

Micro-Portable Projector

LT75Z

User's Manual

English 

Deutsch 

Français 

Italiano 

Español 

Svenska 

IMPORTANT INFORMATION

Precautions

Please read this manual carefully before using your NEC LT75Z Projector and keep the manual handy for future reference. Your serial number is located on the bottom of your LT75Z. Record it here:

CAUTION



To turn off main power, be sure to remove the plug from power outlet. The power outlet socket should be installed as near to the equipment as possible, and should be easily accessible.

CAUTION



TO PREVENT SHOCK, DO NOT OPEN THE CABINET. NO USER-SERVICEABLE PARTS INSIDE. REFER SERVICING TO QUALIFIED NEC SERVICE PERSONNEL.



This symbol warns the user that uninsulated voltage within the unit may be sufficient to cause electrical shock. Therefore, it is dangerous to make any kind of contact with any part inside of the unit.



This symbol alerts the user that important information concerning the operation and maintenance of this unit has been provided. The information should be read carefully to avoid problems.

WARNING

TO PREVENT FIRE OR SHOCK, DO NOT EXPOSE THIS UNIT TO RAIN OR MOISTURE. DO NOT USE THIS UNIT'S GROUNDED PLUG WITH AN EXTENSION CORD OR IN AN OUTLET UNLESS ALL THREE PRONGS CAN BE FULLY INSERTED. DO NOT OPEN THE CABINET. THERE ARE HIGH-VOLTAGE COMPONENTS INSIDE. ALL SERVICING MUST BE DONE BY QUALIFIED NEC SERVICE PERSONNEL.

DOC Compliance Notice

This Class B digital apparatus meets all requirements of the Canadian Interference-Causing Equipment Regulations.

3. GSGV Acoustic Noise Information Ordinance:

The sound pressure level is less than 70 dB (A) according to ISO 3744 or ISO 7779.

RF Interference

WARNING

The Federal Communications Commission does not allow any modifications or changes to the unit EXCEPT those specified by NEC Technologies in this manual. Failure to comply with this government regulation could void your right to operate this equipment.

This equipment has been tested and found to comply with the limits for a Class B digital device, pursuant to Part 15 of the FCC Rules. These limits are designed to provide reasonable protection against harmful interference in a residential installation. This equipment generates, uses, and can radiate radio frequency energy and, if not installed and used in accordance with the instructions, may cause harmful interference to radio communications. However, there is no guarantee that interference will not occur in a particular installation. If this equipment does cause harmful interference to radio or television reception, which can be determined by turning the equipment off and on, the user is encouraged to try to correct the interference by one or more of the following measures:

- Reorient or relocate the receiving antenna.
- Increase the separation between the equipment and receiver.
- Connect the equipment into an outlet on a circuit different from that to which the receiver is connected.
- Consult the dealer or an experienced radio /TV technician for help.

In UK, a BS approved power cable with moulded plug has a Black (five Amps) fuse installed for use with this equipment. If a power cable is not supplied with this equipment please contact your supplier.

- IBM is a registered trademark of International Business Machines Corporation.
- Macintosh and PowerBook are registered trademarks of Apple Computer, Inc.
- Other product and company names mentioned in this user's manual may be the trademarks of their respective holders.

Important Safeguards

These safety instructions are to ensure the long life of your projector and to prevent fire and shock. Please read them carefully and heed all warnings.

Installation

1. For best results, use your projector in a darkened room.
2. Place the projector on a flat, level surface in a dry area away from dust and moisture.
3. Do not place your projector in direct sunlight, near heaters or heat radiating appliances.
4. Exposure to direct sunlight, smoke or steam can harm internal components.
5. Handle your projector carefully. Dropping or jarring can damage internal components.
6. Do not place heavy objects on top of the projector.
7. If you wish to have the projector installed on the ceiling:
 - a. Do not attempt to install the projector yourself.
 - b. The projector must be installed by qualified technicians in order to ensure proper operation and reduce the risk of bodily injury.
 - c. In addition, the ceiling must be strong enough to support the projector and the installation must be in accordance with any local building codes.
 - d. Please consult your dealer for more information.

Power Supply

1. The projector is designed to operate on a power supply of 100-120 or 200-240 V 50/60 Hz AC. Ensure that your power supply fits this requirement before attempting to use your projector.
2. Handle the power cable carefully and avoid excessive bending. A damaged cord can cause electric shock or fire.
3. If the projector is not to be used for an extended period of time, disconnect the plug from the power outlet.

Cleaning

1. Unplug the projector before cleaning.
2. Clean the cabinet periodically with a damp cloth. If heavily soiled, use a mild detergent. Never use strong detergents or solvents such as alcohol or thinner.
3. Use a blower or lens paper to clean the lens, and be careful not to scratch or mar the lens.

CAUTION

Do not turn off the main power or unplug the power cable from the wall outlet under any one of the following circumstances. Doing so can cause damage to the projector:

- Immediately after the power cable is plugged into the wall outlet (when the POWER indicator has not changed to a steady orange glow).
- Immediately after the cooling fan stops working (The cooling fan continues to work for 90 seconds after the projector is turned off with the POWER button).

Lamp Replacement

- To replace the lamp, follow all instructions provided on page E-34.
- Be sure to replace the lamp when the message "The lamp has reached the end of its usable life. Please replace the lamp." appears. If you continue to use the lamp after the lamp has reached the end of its usable life, the lamp bulb may shatter, and pieces of glass may be scattered in the lamp case. Do not touch them as the pieces of glass may cause injury. If this happens, contact your NEC dealer for lamp replacement.
- Allow a minimum of 90 seconds to elapse after turning off the projector. Then disconnect the power cable and allow 60 minutes to cool the projector before replacing the lamp.

Fire and Shock Precautions

1. Ensure that there is sufficient ventilation and that vents are unobstructed to prevent the build-up of heat inside your projector. Allow at least 3 inches (10cm) of space between your projector and a wall.
2. Prevent foreign objects such as paper clips and bits of paper from falling into your projector. Do not attempt to retrieve any objects that might fall into your projector. Do not insert any metal objects such as a wire or screwdriver into your projector. If something should fall into your projector, disconnect it immediately and have the object removed by a qualified NEC service personnel.
3. **Do not place any liquids on top of your projector.**
 - Do not look into the lens while the projector is on. Serious damage to your eyes could result.
 - Keep any items such as magnifying glass out of the light path of the projector. The light being projected from the lens is extensive, therefore any kind of abnormal objects that can redirect light coming out of the lens, can cause unpredictable outcome such as fire or injury to the eyes.
 - Do not cover the lens with the supplied lens cap or equivalent while the projector is on. Doing so can lead to melting of the cap and possibly burning your hands due to the heat emitted from the light output.

TABLE OF CONTENTS

1. INTRODUCTION

Introduction to the LT75Z Projector	E-6
Getting Started	E-6
What's in the Box	E-7
Getting to Know Your LT75Z Projector	E-8
Front / Side Features	E-8
Attaching the lens cap	E-8
Rear / Side Features	E-9
Top Features	E-10
Terminal Panel Features	E-11
Remote Control Features	E-12
Remote Control Battery Installation	E-13
Operating Range	E-13
Remote Control Precautions	E-13

2. INSTALLATION

Setting Up Your Projector	E-14
Selecting a Location	E-14
Screen and Projection Distance	E-14
Distance Chart	E-15
Reflecting the Image	E-15
Wiring Diagram	E-16
Connecting Your PC or Macintosh Computer	E-17
Connecting Your DVD Player	E-18
Connecting Your VCR or Laser Disc Player	E-19
About Startup screen (Menu Language Select screen)	E-20

3. OPERATION

Connecting the Power Cable and Turn on the Projector	E-21
Adjusting the Image Size and the Focus	E-22
Adjusting the Image Using Auto Adjust	E-23
Enlarging and Moving a Picture	E-24
Using the Menus	E-24
Menu Tree	E-25
Menu Elements	E-26
Menu Descriptions & Functions	E-27
Source Select	E-27
RGB/Video/S-Video	
Picture	E-27
Brightness/Contrast/Color/Hue/Sharpness	
Volume	E-27
Image Options	E-27
Keystone	E-27
Lamp Mode	E-28
Aspect Ratio	E-28
Position/Clock	E-29
Resolution	E-29
Video Filter	E-29
Factory Default	E-29
Color Management	E-30
Gamma Correction	E-30
White Balance	E-30
Projector Options	E-30
Menu	E-30
Menu Mode	E-30
Basic Menu/Advanced Menu	
Language	E-30
Source Display	E-30
No Input Display	E-30
Volume Bar	E-30
Keystone Bar	E-31
Menu Display Time	E-31

Setup	E-31
Orientation	E-31
Cinema Position	E-31
Background	E-31
Signal Select RGB	E-31
Signal Select Video/S-Video	E-31
Auto Adjust	E-32
Auto Start	E-32
Power Management	E-32
Power Off Confirmation	E-32
Keystone Save	E-32
White Segment	E-32
Default Source Select	E-32
Communication Speed	E-32
Control Panel Key Lock	E-32
Clear Lamp Hour Meter	E-33
Information	E-33

4. MAINTENANCE

Replacing the Lamp	E-34
--------------------------	------

5. TROUBLESHOOTING

Power/Status Light Messages	E-35
Common Problems & Solutions	E-35

6. SPECIFICATIONS

Optical/Electrical/Mechanical	E-36
Cabinet Dimensions	E-37
D-Sub Pin Assignments	E-38
Compatible Input Signal List	E-39
PC Control Codes	E-40
Cable Connection	E-40

1. INTRODUCTION

Introduction to the LT75Z Projector

This section introduces you to your new LT75Z Projector and describes the features and controls.

Congratulations on Your Purchase of The LT75Z Projector

The LT75Z is one of the very best projectors available today. The LT75Z enables you to project precise images up to 200 inches across (measured diagonally) from your PC or Macintosh computer (desktop or notebook), VCR, DVD player, document camera or a laser disc player.

You can use the projector on a tabletop or cart, you can use the projector to project images from behind the screen, and the projector can be permanently mounted on a ceiling*¹. The remote control can be used wirelessly.

Features you'll enjoy:

- Simple set up and operation.
- A high-performance 135 watt NSH lamp.
- The supplied wireless remote control that operates the projector from the front or rear.
- The image can be projected between 30 and 200 inches (measured diagonally).
- Keystone correction allows you to correct trapezoidal distortion so that the image is square.
- You can choose between video modes depending on your source:
"normal" for a typical picture, "natural" for true color reproduction.
- An image can be projected from in front or behind a screen, and the projector can even be installed on the ceiling.
- NEC Technologies' exclusive Advanced AccuBlend intelligent pixel blending technology - an extremely accurate image compression technology - offers a crisp image with UXGA (1600 × 1200) resolution*².
- Supports most IBM VGA, SVGA, XGA*², SXGA*², UXGA*² Macintosh, component signal (YCbCr / YPbPr) or any other RGB signals within a horizontal frequency range of 15 to 100 kHz and a vertical frequency range of 50 to 120Hz. This includes NTSC, PAL, PAL-N, PAL-M, PAL60, SECAM and NTSC4.43 standard video signals.

NOTE: Composite video standards are as follows:

NTSC: U.S. TV standard for video in U.S. and Canada.

PAL: TV standard used in Western Europe.

PAL-M: TV standard used in Brazil.

PAL-N: TV standard used in Argentina, Paraguay and Uruguay.

PAL60: TV standard used for NTSC playback on PAL TVs.

SECAM: TV standard used in France and Eastern Europe.

NTSC4.43: TV standard used in Middle East countries.

- You can control the projector with a PC using the PC Control port.
- The contemporary cabinet design is light, compact, easy to carry, and complements any office, boardroom or auditorium.

*¹ Do not attempt to mount the projector on a ceiling yourself. The projector must be installed by qualified technicians in order to ensure proper operation and reduce the risk of bodily injury. In addition, the ceiling must be strong enough to support the projector and the installation must be in accordance with any local building codes. Please consult your dealer for more information.

*² An XGA image (1024 × 768), SXGA image (1280 × 1024) and UXGA image (1600 × 1200) are converted into an 800 × 600 crisp image with NEC technology's Advanced AccuBlend.

Getting Started

The fastest way to get started is to take your time and do everything right the first time. Take a few minutes now to review the user's manual. This may save you time later on. At the beginning of each section of the manual you'll find an overview. If the section doesn't apply, you can skip it.

What's in the Box?

Make sure your box contains everything listed. If any pieces are missing, contact your dealer.
Please save the original box and packing materials if you ever need to ship your LT75Z Projector.

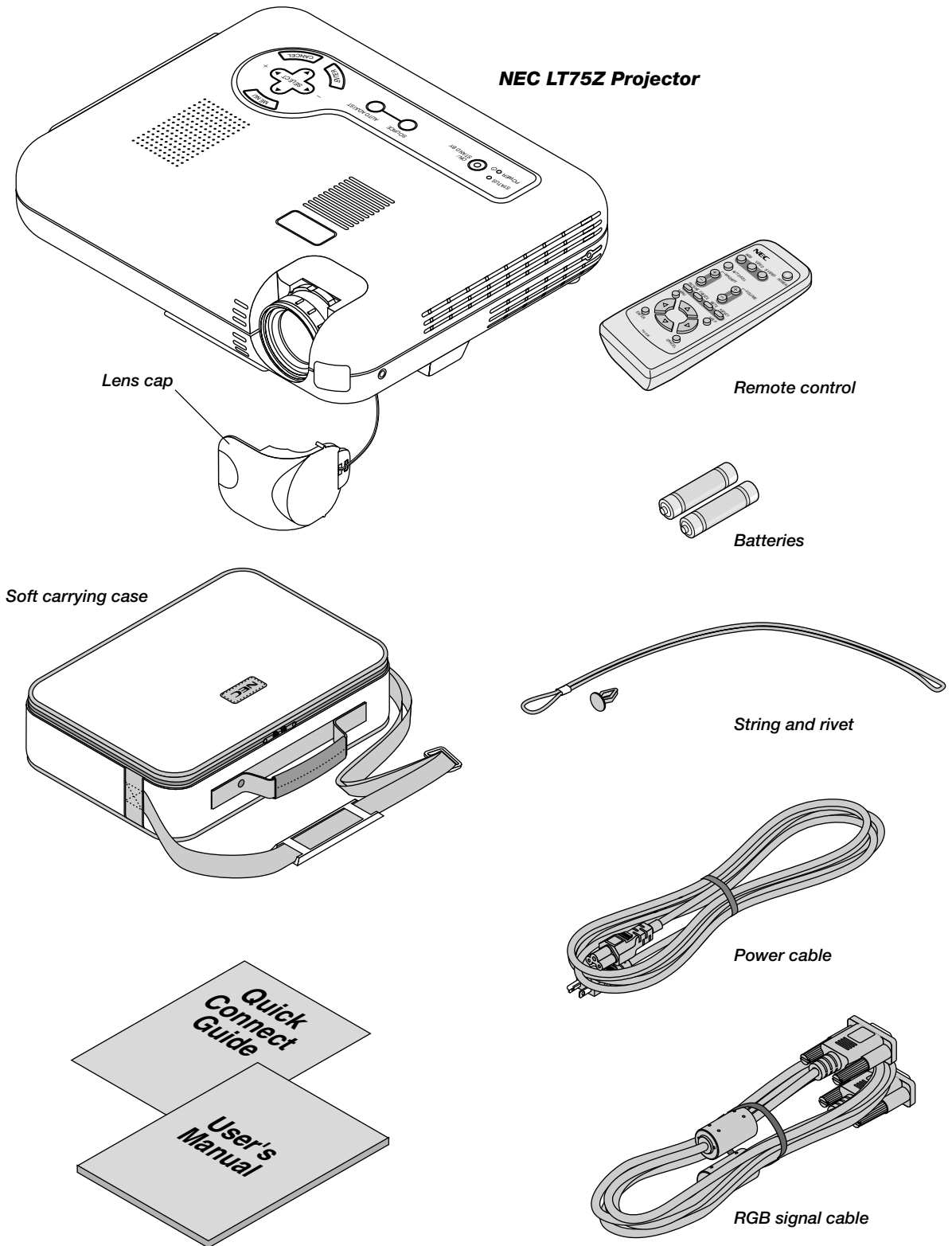

Getting to Know Your LT75Z Projector

Front/Side Features

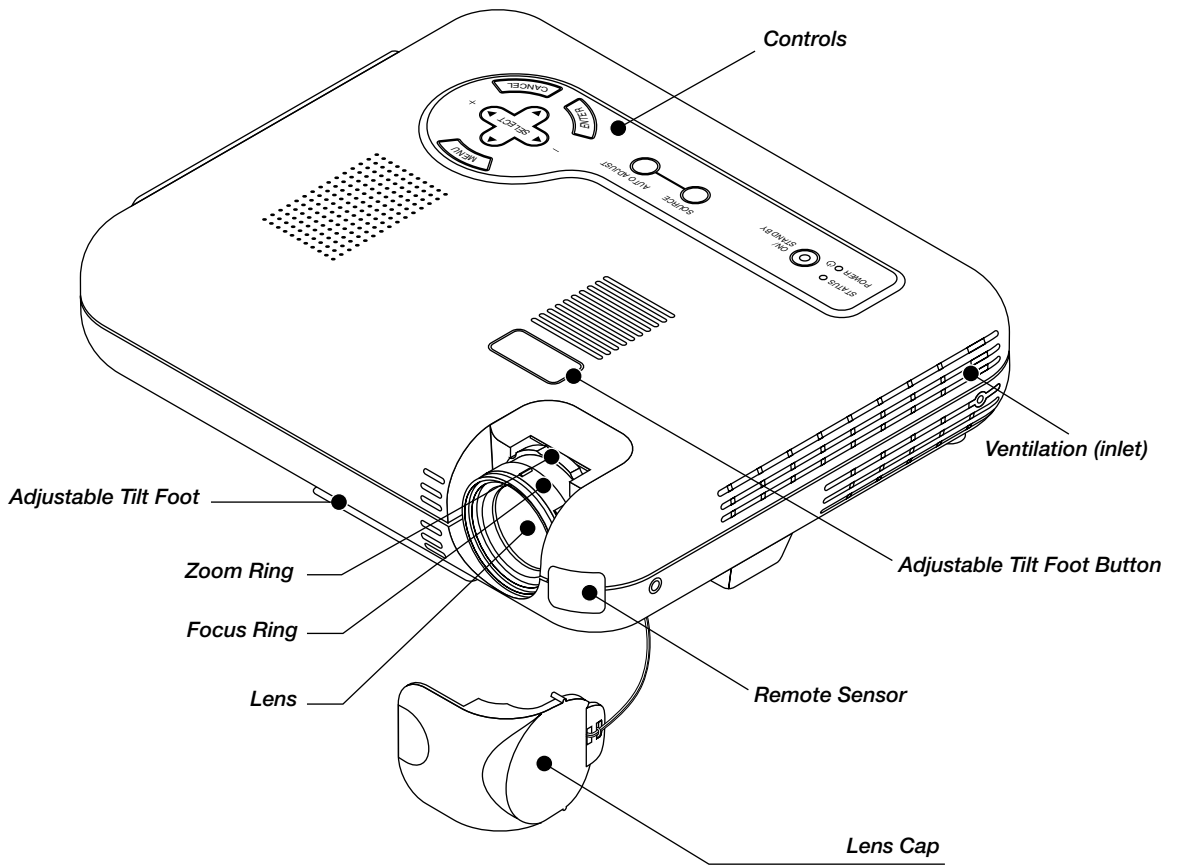

Attaching the lens cap to the bottom with the supplied string and rivet

1. Thread the string through the hole on the lens cap and then tie a knot in the string.
2. Use the rivet to attach the string to the bottom of the projector.

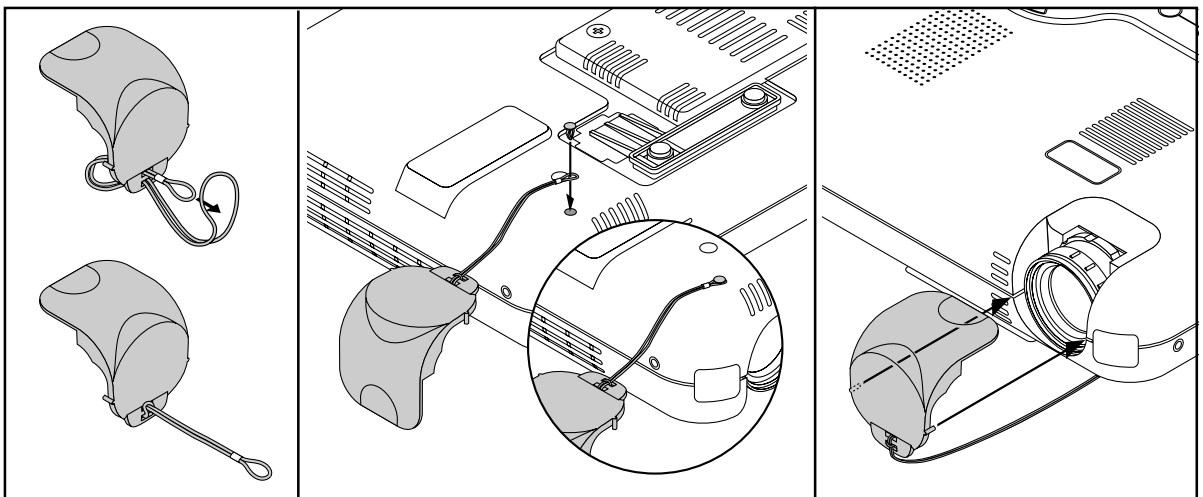

Rear/Side Features

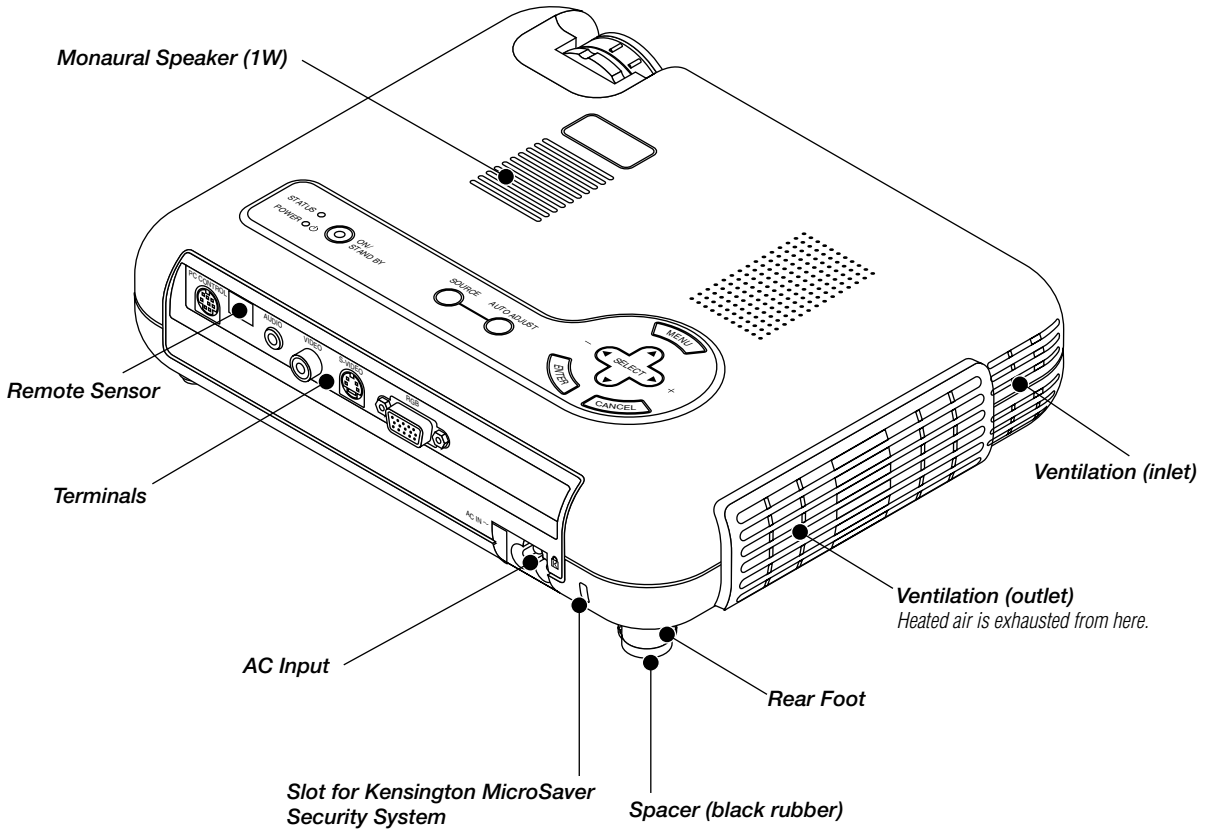

Bottom

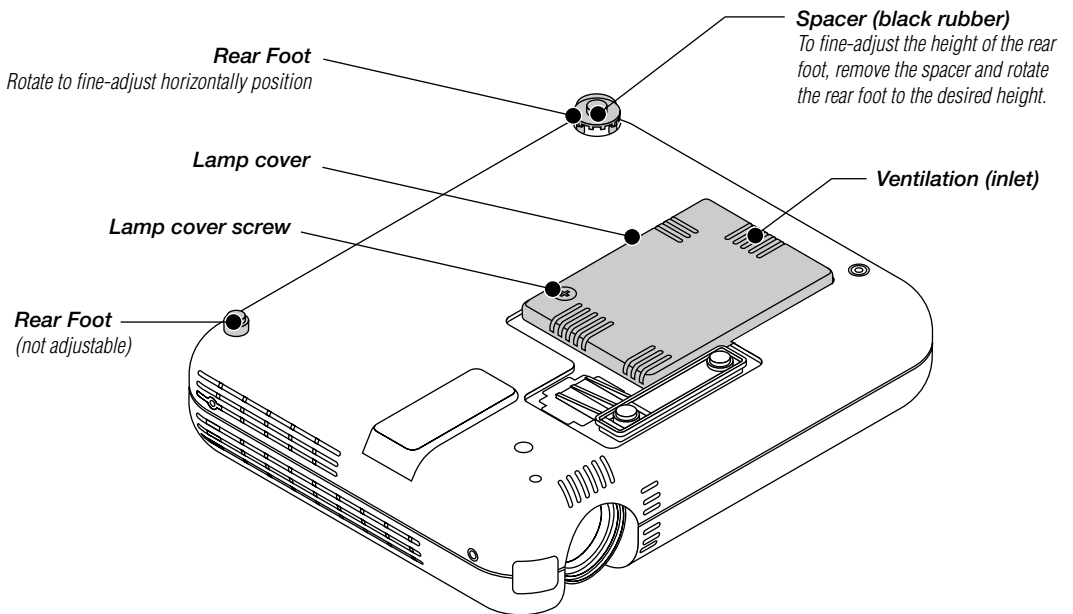

NOTE: The projector has an internal temperature sensor. The sensor controls the speed of the fan to keep constant temperature in the inside. When the internal temperature rises, the built-in fan automatically runs at a high speed (high-speed mode). During this time, the sound of exhaust may be heard. This is not a malfunction.

Top Features

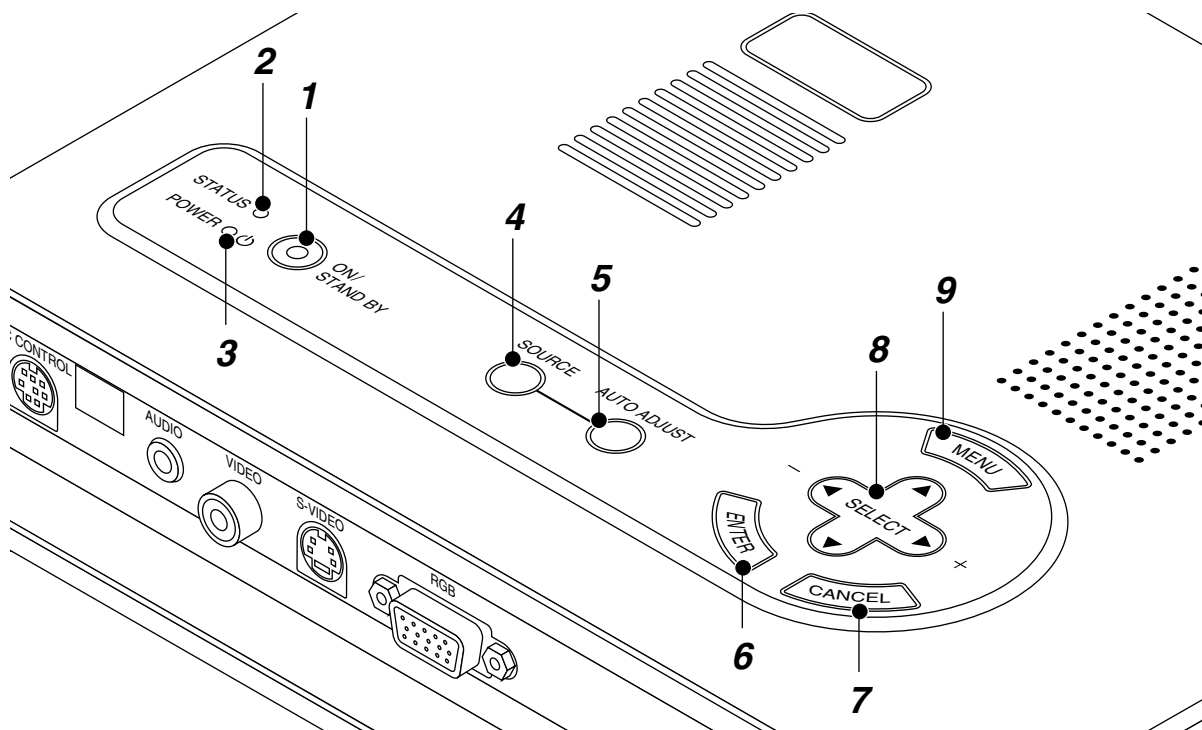

1. Power Button (ON / STAND BY)

Use this button to turn the power on and off when the power is supplied and the projector is in standby mode.

NOTE: To turn off the projector, press and hold this button for a minimum of two seconds.

2. Status Indicator

When this is lit red continually, it's warning you that the projection lamp has exceeded 1000 hours (1500 hours in Eco mode) of service. After this light appears, it is advisable to replace the projection lamp as soon as possible. (See page E-34). In addition the message **"The lamp has reached the end of its usable life. Please replace the lamp."** appears continually until the lamp is replaced.

If this light blinks red rapidly, it indicates that the lamp cover is not attached properly or the projector is overheated.

See the Power/Status Light Messages on page E-35 for more details.

3. Power Indicator (⏻)

When this indicator is green, the projector is on; when the indicator is orange, it is in standby mode.

4. Source Button

Use this button to select a video source such as a PC, VCR or DVD player.

Each time this button is pressed, the input source will change as follows:



If no input signal is present, the input will be skipped.

5. Auto Adjust Button (RGB only)

Use this button to adjust Position-H/V and Pixel Clock/Phase for an optimal picture. Some signals may not be displayed correctly or take time to switch between sources.

6. Enter Button

Executes your menu selection and activates items selected from the menu.

7. Cancel Button

Press this button to close the menu.

8. Select (▲▼◀▶) Buttons

▲▼: Use these buttons to select the menu of the item you wish to adjust.

◀▶: Use these buttons to change the level of a selected menu item.

9. Menu Button

Displays the menu.

Terminal Panel Features

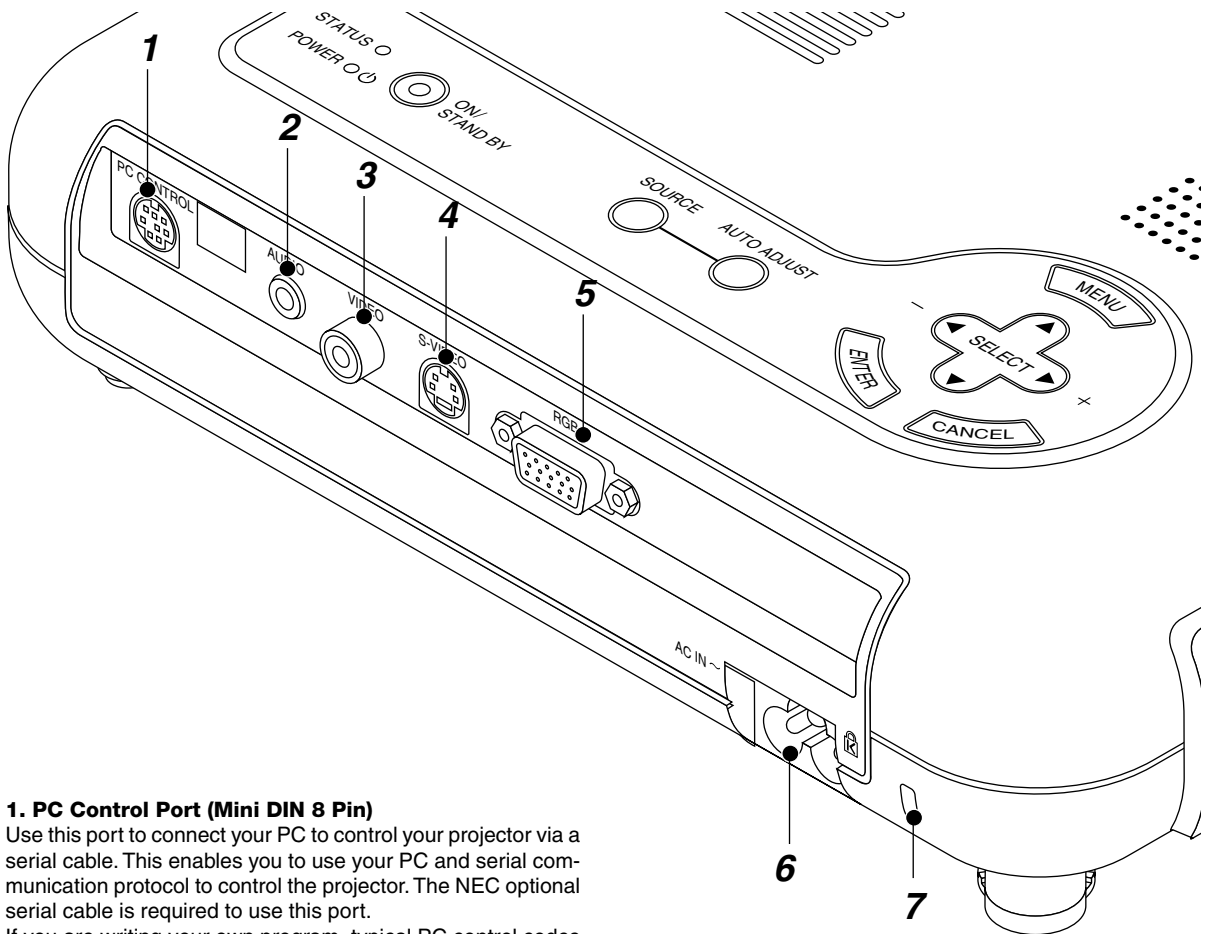

1. PC Control Port (Mini DIN 8 Pin)

Use this port to connect your PC to control your projector via a serial cable. This enables you to use your PC and serial communication protocol to control the projector. The NEC optional serial cable is required to use this port.

If you are writing your own program, typical PC control codes are on page E-40.

A cap is put on the port at the factory. Remove the cap when using the port.

2. Audio Input Mini Jack (3.5 mm Ø)

This is where you connect audio output from your computer, VCR, DVD player or laser disc player.

A commercially available audio cable is required.

3. Video Input (RCA)

Connect a VCR, DVD player, laser disc player, or document camera here to project video.

4. S-Video Input (Mini DIN 4 Pin)

Here is where you connect the S-Video input from an external source like a VCR.

NOTE: S-Video provides more vivid color and higher resolution than the traditional composite video format.

5. RGB Input/Component Input Connector (Mini D-Sub 15 pin)

Connect your PC or other RGB equipment such as IBM or compatible computers. Use the supplied RGB cable to connect to a PC. Or connect a Macintosh computer here using the supplied RGB cable. This also serves as a component input connector that allows you to connect a component video output of component equipment such as a DVD player.

6. AC Input

Connect the supplied power cable's three-pin plug here. When you plug the other end into an active wall outlet, the POWER indicator turns orange and the projector is in standby mode.

7. Built-in Security Slot (K)

This security slot supports the MicroSaver® Security System. MicroSaver® is a registered trademark of Kensington Microware Inc.

The logo is trademarked and owned by Kensington Microware Inc.

Remote Control Features

1. Infrared Transmitter

Direct the remote control toward the remote sensor on the projector cabinet.

2. Power Button

If power is applied, you can use this button to turn your projector on and off.

NOTE: To turn off the projector, press and hold the POWER button for a minimum of two seconds.

3. Source Buttons

Press to select a video source.

4. Auto Adjust Button

Use this button to adjust Position-H/V and Pixel Clock/Phase for an optimal picture. Some signals may not be displayed correctly, or in some cases it may take some time for a source to switch between sources.

5. Magnify Buttons

Use the (+) or (-) button to adjust the image size up to 400%.

6. Volume Buttons

Press (+) to increase the volume and (-) to decrease it.

7. Picture Button

Press this button to display the Picture adjustment window. Each time this button is pressed, the current picture adjustment item will change as follows:

→ **Brightness** → **Contrast** → **Color** → **Hue** → **Sharpness** →

Unavailable items will be skipped.

8. Freeze Button

This button will freeze a picture. Press again to resume motion.

9. Mute Button

This button turns off the image and sound for a short period of time. Press again to restore the image and sound.

10. Aspect Button

Press this button to display the Aspect Ratio select window. Each time this button is pressed, the current aspect ratio will change as follows:

→ **Normal** → **Zoom** → **Wide Zoom** → **Cinema** →

You can also select the aspect ratio by using the Select ◀ or ▶ button. If no adjustments are performed within 3 seconds, the Aspect Ratio select window will disappear. (See also page E-28.)

11. Menu Button

Displays the menu.

12. Help Button

Provides information about the current signal and the status of the projector.

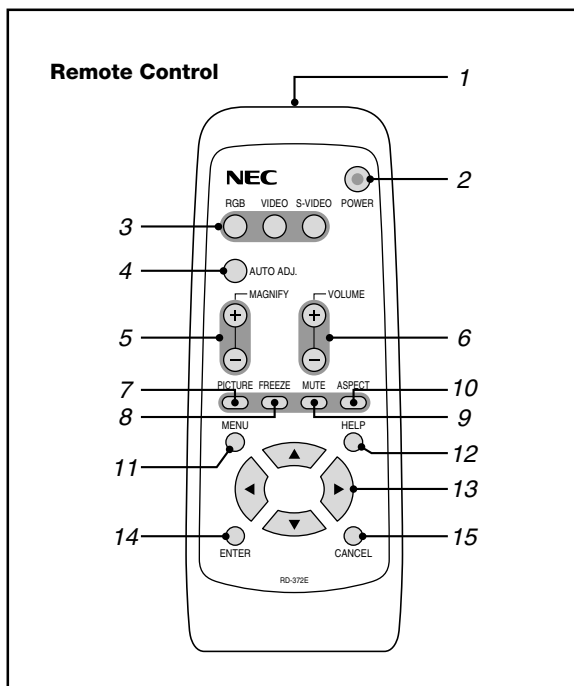

13. Select (▲▼◀▶) Buttons

▲▼ : Use these buttons to select the menu of the item you wish to adjust.

◀▶ : Use these buttons to change the level of a selected menu item.

14. Enter Button

Executes your menu selection and activates items selected from the menu.

15. Cancel Button

Press this button to exit the menu. While you are in the adjustment or setting menu, pressing this button will return to the previous menu.

Remote Control Battery Installation

1. Push to open the battery cover.

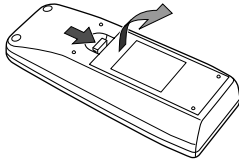

2. Remove both old batteries and install new ones (AA). Ensure that you have the batteries' polarity (+/-) aligned correctly.

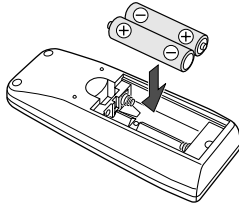

3. Put the battery cover back on.

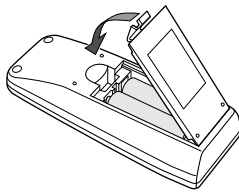

Do not mix different types of batteries or new and old batteries.

Operating Range

The infrared signal operates by line-of-sight up to a distance of approximately 22 feet (7m) and within a 60-degree angle of the remote sensor. The projector will not function if there are objects between the remote control and the remote sensor on the projector or if strong light falls on the remote sensor. A weak battery will also prevent the projector from operating properly.

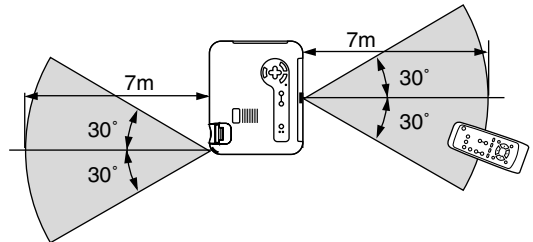

This sample may be slightly different from actual range

Remote Control Precautions

- Handle the remote control carefully.
- If the remote control gets wet, wipe it dry immediately.
- Avoid excessive heat and humidity.
- Do not place the battery upside down.
- If you will not be using the remote control for a long time, remove the batteries.

CAUTION:

Danger of explosion if battery is incorrectly replaced. Replace only with the same or equivalent type recommended by the manufacturer. Dispose of used batteries according to your local regulations.

2. INSTALLATION

This section describes how to set up your LT75Z projector and how to connect video and audio sources.

Setting up Your Projector

Your LT75Z Projector is simple to set up and use. But before you get started, you must first:

1. Determine the image size.
2. Set up a screen or select a non-glossy white wall onto which you can project your image.
 - Ensure that the power cable and any other cables connecting to video sources are disconnected before moving the projector.
 - When moving the projector or when it is not in use, cover the lens with the lens cap.

Selecting a Location

The further your projector is from the screen or wall, the larger the image. The minimum size the image can be is approximately 30" (0.8 m) measured diagonally when the projector is roughly 4 feet (1.3m) from the wall or screen. The largest the image can be is 200" (5.1 m) when the projector is about 30 feet (9.2m) from the wall or screen.

Screen and Projection Distance

The following shows the proper relative positions of the projector and screen. Refer to the table to determine the position of installation.

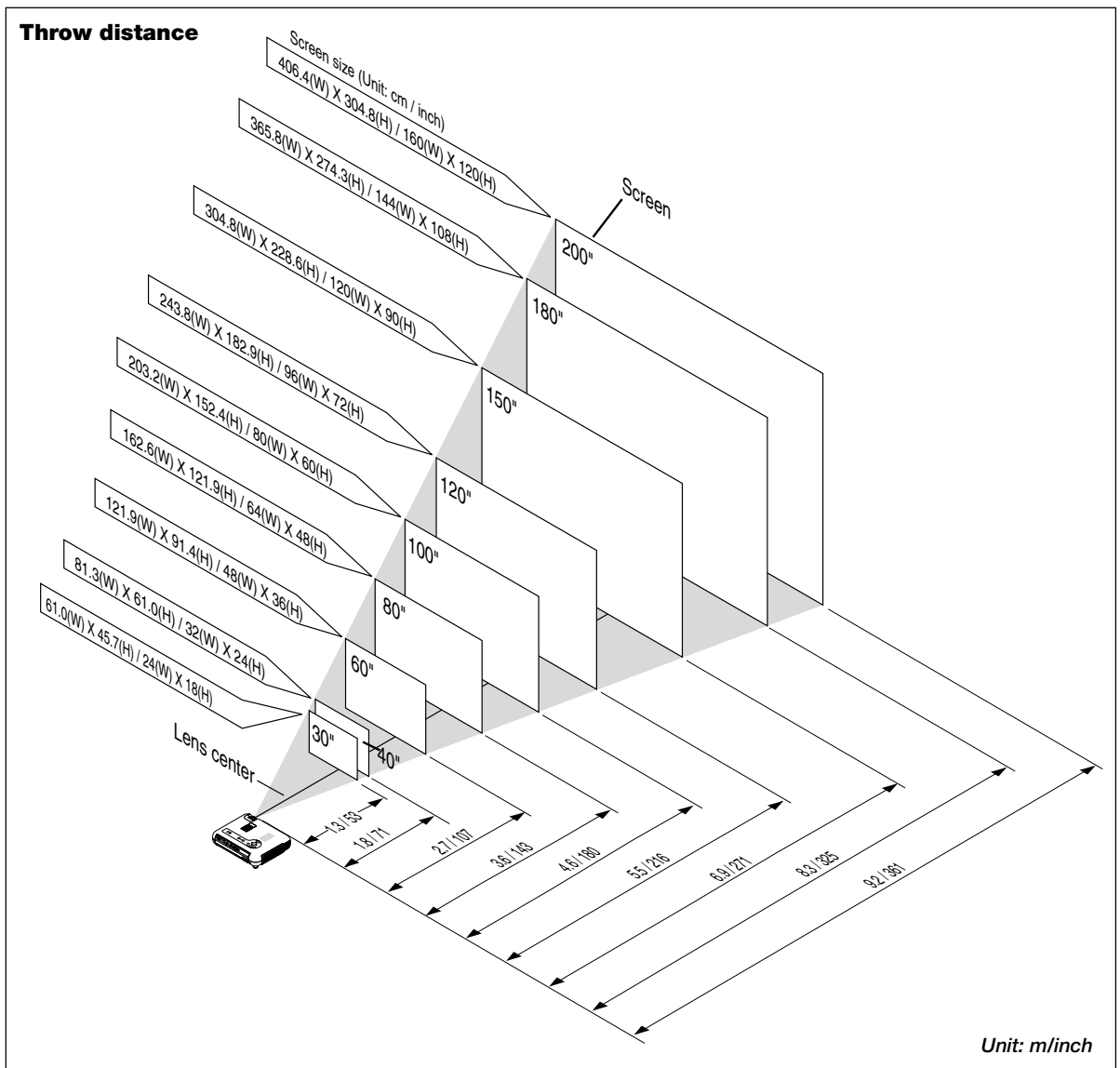

Distance Chart

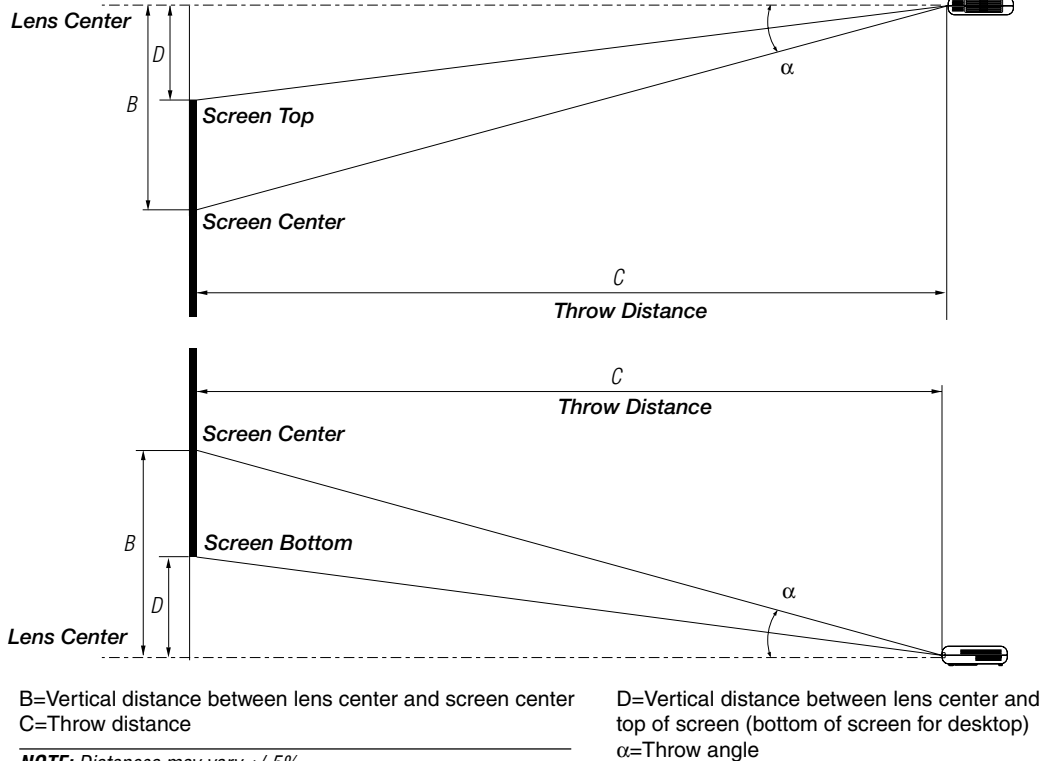

Screen Size						B	C				D	α			
Diagonal		Width		Height			Wide		Tele			Wide		Tele	
inch	mm	inch	mm	inch	mm	inch	mm	inch	mm	inch	mm	degree	degree		
30	762	24	610	18	457	13	319	48	1210	58	1470	4	90	14.8	12.2
40	1016	32	813	24	610	17	425	64	1620	78	1970	5	120	14.7	12.2
60	1524	48	1219	36	914	25	637	97	2460	117	2980	7	180	14.5	12.1
67	1702	54	1361	40	1021	28	712	108	2750	131	3340	8	201	14.5	12.0
72	1829	58	1463	43	1097	30	765	117	2960	141	3590	9	216	14.5	12.0
80	2032	64	1626	48	1219	33	850	130	3300	157	3990	9	240	14.4	12.0
84	2134	67	1707	50	1280	35	892	136	3460	165	4190	10	252	14.5	12.0
90	2286	72	1829	54	1372	38	956	146	3710	177	4500	11	270	14.5	12.0
100	2540	80	2032	60	1524	42	1062	163	4130	197	5000	12	300	14.4	12.0
120	3048	96	2438	72	1829	50	1275	196	4970	237	6010	14	360	14.4	12.0
150	3810	120	3048	90	2286	63	1593	245	6220	296	7530	18	450	14.4	11.9
180	4572	144	3658	108	2743	75	1912	294	7470	356	9040	21	541	14.4	11.9
200	5080	160	4064	120	3048	84	2125	327	8310	396	10050	24	601	14.3	11.9

WARNING

- Installing your projector on the ceiling must be done by a qualified technician. Contact your dealer for more information.
- * Do not attempt to install the projector yourself.
- Only use your projector on a solid, level surface. If the projector falls to the ground, you can be injured and the projector severely damaged.
- Do not use the projector where temperatures vary greatly. The projector must be used at temperatures between 41°F (5°C) and 95°F (35°C).
- Do not expose the projector to moisture, dust, or smoke. This will harm the screen image.
- Ensure that you have adequate ventilation around your projector so heat can dissipate. Do not cover the vents on the side or the front of the projector.

Reflecting the Image

Using a mirror to reflect your projector's image enables you to enjoy a much larger image. Contact your NEC dealer if you need a mirror. If you're using a mirror and your image is inverted, use the "Menu" and "Select" buttons on your projector cabinet or ▲▼ buttons on your remote control to correct the orientation. (See page E-31.)

Wiring Diagram

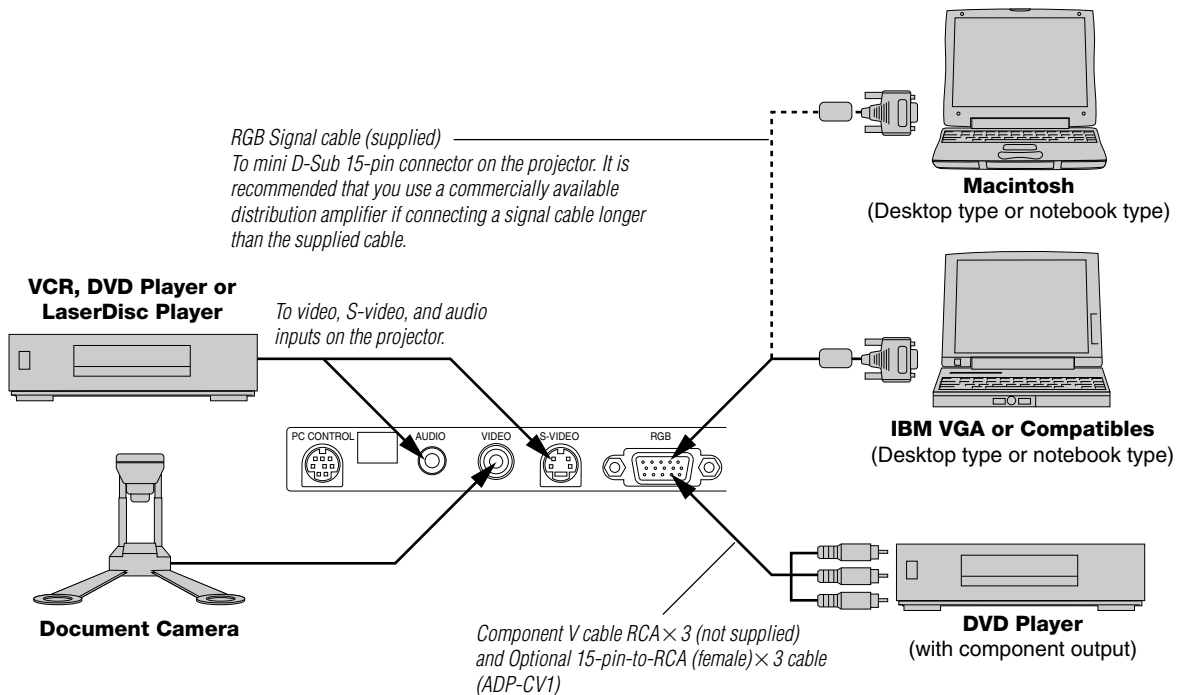

NOTE: When using with a notebook PC, be sure to connect between the projector and the notebook PC before turning on the power to the notebook PC. In most cases signal cannot be output from RGB output unless the notebook PC is turned on after connecting with the projector.

NOTE:

- * If the screen goes blank while using your remote control, it may be the result of the computer's screen-saver or power management software.
- * If you accidentally hit the POWER button on the remote control, wait 90 seconds and then press the POWER button again to resume.

NOTE: If using video, S-video, or audio cables, the cables should be 3 m (9.8 feet) or shorter.

To connect SCART output (RGB)

Before connections: An exclusive SCART adapter (ADP-SC1) and a commercially available SCART cable are required for this connection.

NOTE: Audio signal is not available for this connection.

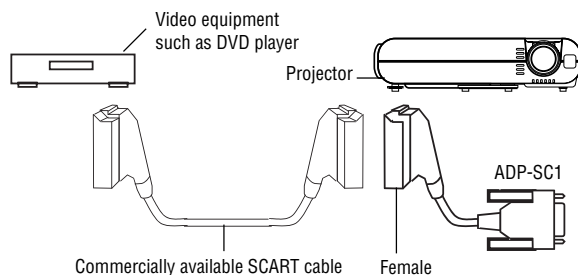

1. Turn off the power to the projector and your video equipment.
2. Use the NEC ADP-SC1 SCART adapter and a commercially available SCART cable to connect the RGB input of your projector and a SCART output (RGB) of your video equipment.

3. Turn on the power to the projector and your video equipment.
4. Use the RGB button on the remote control to select the RGB input.
5. Press the MENU button on the remote control to display the menu.
6. From the Advanced menu, select [Projector Options] → [Setup] → [Signal Select RGB] → [Scart].

SCART is a standard European audio-visual connector for TVs, VCRs and DVD players. It is also referred to as Euro-connector.

NOTE: The ADP-SC1 SCART adapter is obtainable from your NEC dealer in Europe.
Contact your NEC dealer in Europe for more information.

Connecting Your PC or Macintosh Computer

*IBM VGA or Compatibles (Notebook type)
or Macintosh (Notebook type)*

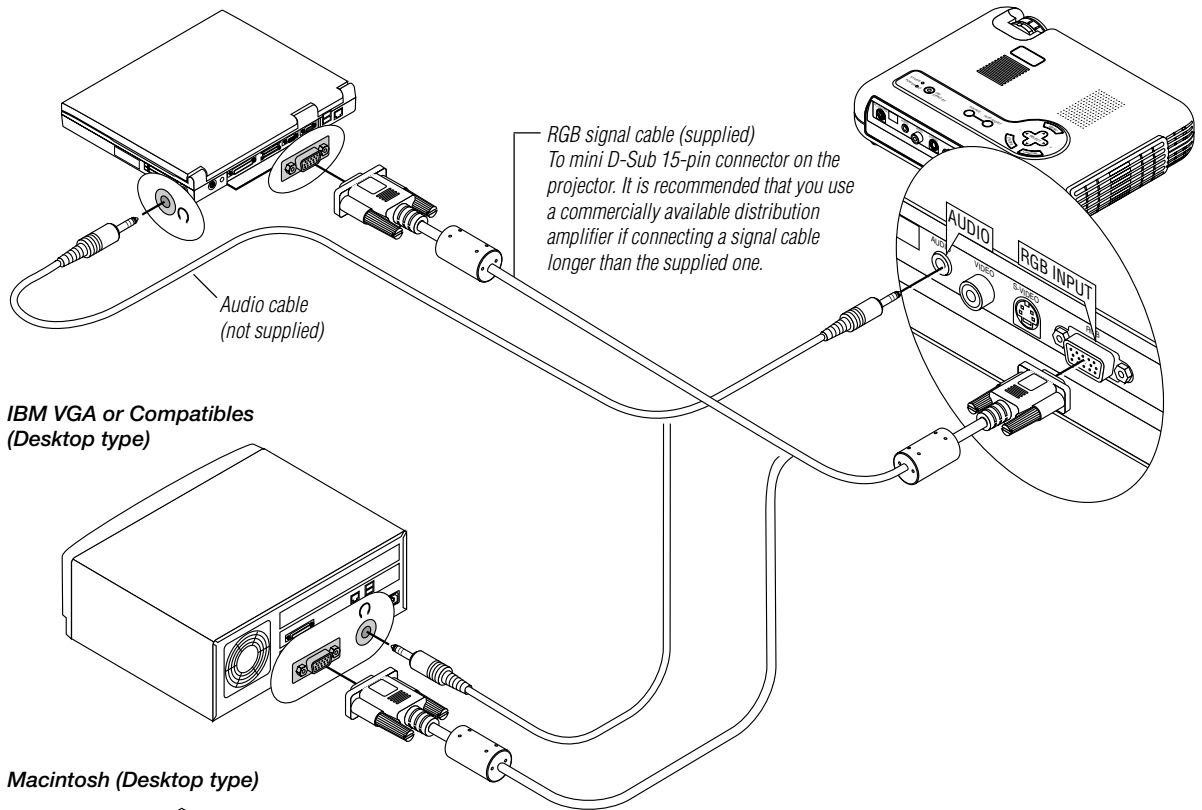

Macintosh (Desktop type)

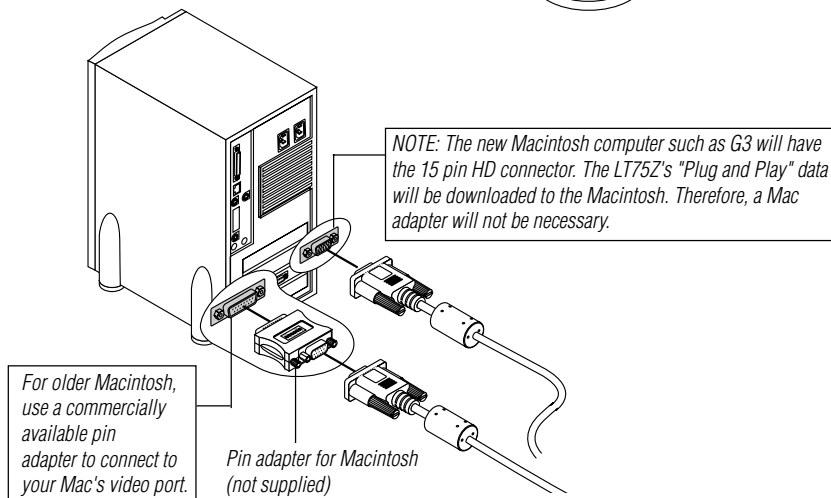

Connecting your PC to your LT75Z (SVGA) projector will enable you to project your computer's screen image for an impressive presentation.

To connect to a PC or Macintosh computer, simply:

1. Turn off the power to your projector and computer.
2. Use the supplied signal cable to connect your PC or Macintosh computer to the projector.
3. Turn on the projector and the computer.
4. If the projector goes blank after a period of inactivity, it may be caused by a screen saver installed on the computer you've connected to the projector.

Connecting Your DVD Player

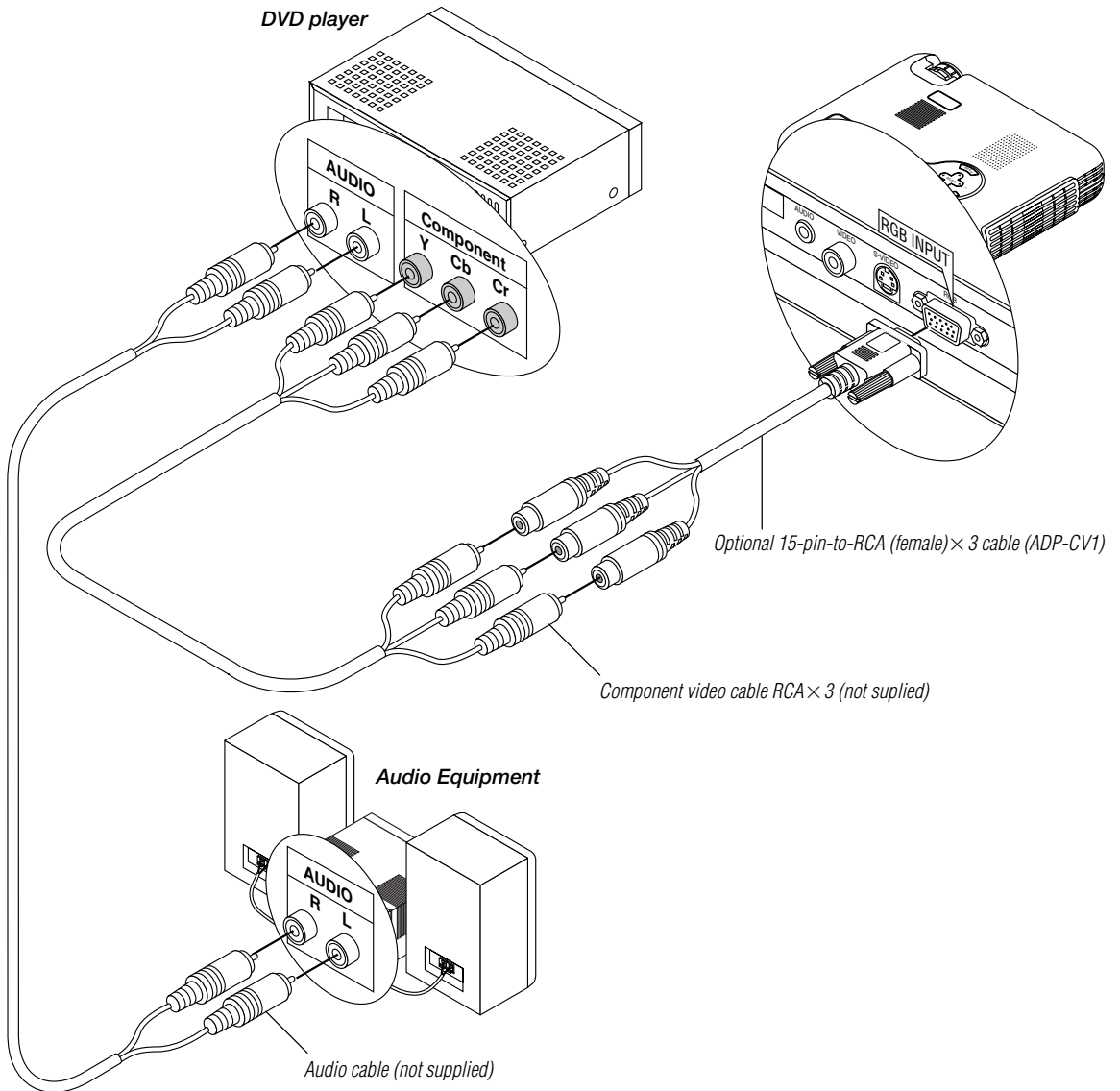

You can connect your projector to a DVD player with component outputs or Video output. To do so, simply:

1. Turn off the power to your projector and DVD player.
2. Use a 15-pin cable to connect your monitor to the RGB Monitor Output (Mini D-Sub 15 pin) connector on your projector.

For a DVD player without component video (Y,Cb,Cr) outputs, use common RCA cables (not provided) to connect a composite VIDEO output of the DVD player to the Video Input of the projector.

3. Turn on the projector and DVD player.

NOTE: Refer to your DVD player's owner's manual for more information about your DVD player's video output requirements.

Connecting Your VCR or Laser Disc Player

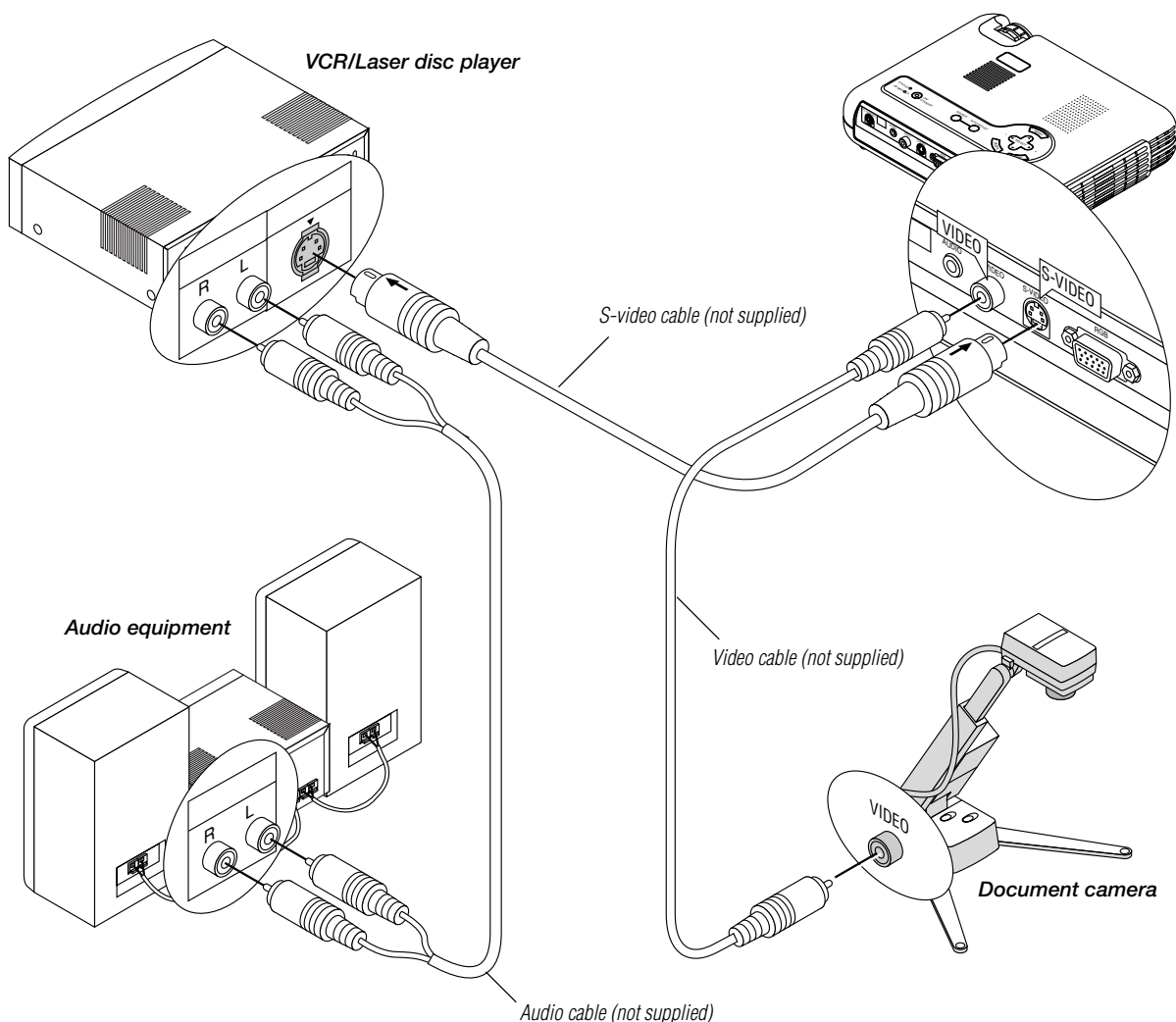

Use common RCA cables (not provided) to connect your VCR, laser disc player or document camera to your projector.

To make these connections, simply:

1. Turn off the power to the projector and VCR, laser disc player or document camera.
2. Connect one end of your RCA cable to the video output connector on the back of your VCR or laser disc player, connect the other end to the Video input on your projector. Use an audio cable (not supplied) to connect the audio from your VCR or laser disc player to your audio equipment (if your VCR or laser disc player has this capability). Be careful to keep your right and left channel connections correct for stereo sound.
3. Turn on the projector and the VCR or laser disc player.

NOTE: Refer to your VCR or laser disc player owner's manual for more information about your equipment's video output requirements.

NOTE:

- A playback video image may not be displayed or may not be correctly displayed when the projector is used with a scan converter.
- This model does not support the NEC ISS-6010 and ISS-6020 switchers.

About Startup screen

(Menu Language Select screen)

When you first turn on the projector, you will get the Startup screen. This screen gives you the opportunity to select one of the seven menu languages: English, German, French, Italian, Spanish, Swedish and Japanese.

To select a menu language, follow these steps:

1. Use the ▲ or ▼ buttons to select one of the seven languages for the menu.

Menu Language Select	
Please select a menu language.	English
Wählen Sie bitte die Menü Sprache aus.	Deutsch
S'il vous plaît choisir la langue de menu.	Français
Per favore di scegliere la lingua di menu.	Italiano
Escoja por favor el idioma de menú.	Español
Välj menyn språken.	Svenska
メニュー言語を選択してください。	日本語
Select "UP", "DOWN" & "ENTER"	

2. Press the Enter button to execute the selection.
3. The Basic menu will be displayed in the language you have selected.

Basic Menu	
Source Select	▶
Picture	
Volume	
Image Options	▶
Projector Options	▶
Information	

To close the menu, press the Cancel button.

After this has been done, you can proceed to the advanced menu operation.

If you want, you can select the menu language later. See "Language" on page E-30.

3. OPERATION

Connecting the Power Cable and Turn on the Projector

Before you turn on your projector, ensure that the computer or video source is turned on and that your lens cap is removed.

1 Connect the supplied power cable to the projector.

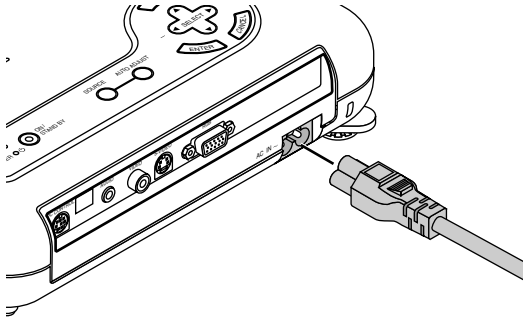

Plug the supplied power cable in the wall outlet. The projector will go into its standby mode and the power indicator will glow orange.

2 Turn on and off the Projector.

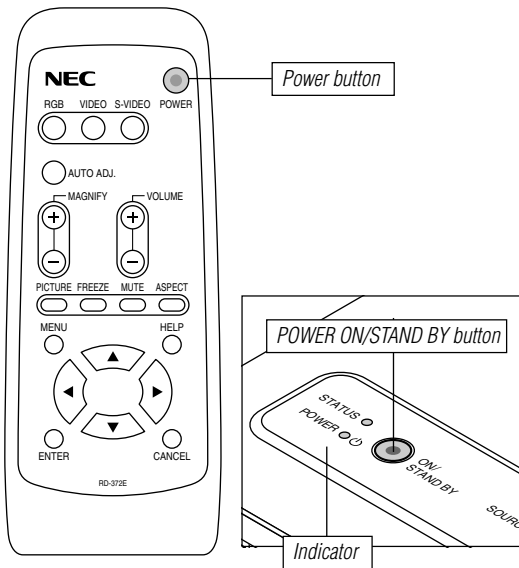

To turn on the projector:

Only after you press the "POWER" button on the projector cabinet or the remote control will the power indicator turn to green and the projector become ready to use.

NOTE: To turn the projector on by plugging in the power cable, use the menu and enable the "Auto Start" feature. (See page E-32.)

NOTE: Immediately after turning on the projector, screen flicker may occur. This is not a fault. Wait 3 to 5 minutes until the lamp lighting is stabilized.

To turn off the projector:

First press the "POWER" button on the projector cabinet or the remote control for a minimum of two seconds. The power indicator will glow orange. After the projector turns off, the cooling fans keep operating for 90 seconds.

NOTE: Do not disconnect the power cable during this time. Then, unplug the power cable. The power indicator will go out.

Status of indicator light: turn on

Normal mode:

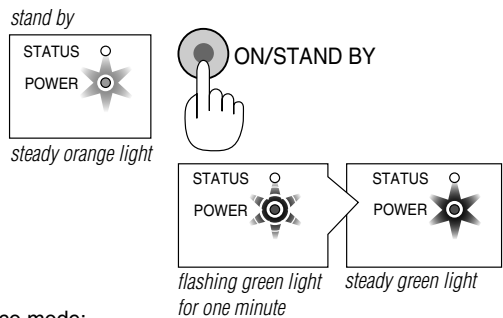

Eco mode:

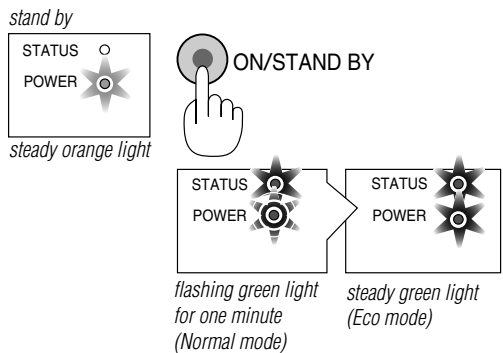

Status of indicator light: turn off

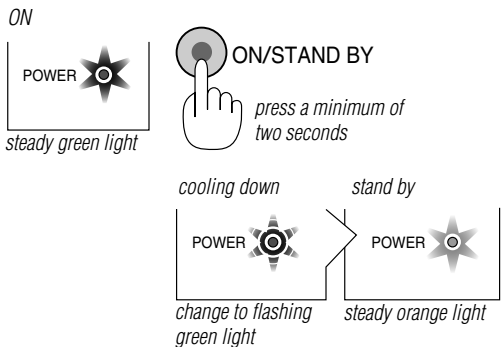

3 Adjust a Projected Image.

Select the Computer or Video Source

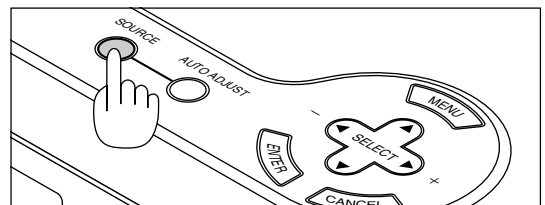

Press the Source button on the remote control or the projector cabinet to select "Video" (VCR, document camera, or laser disc player), "S-Video" or "RGB" (computer or DVD with component output).

Or press the "Menu" button on the remote control or the cabinet and use the menu to select your video source: "Video", "S-Video" or "RGB".

NOTE: If no input signal is available, the projector will display a blue background (factory preset).

Adjusting the Image Size and the Focus

Use the Zoom ring to fine adjust the image size on the screen.

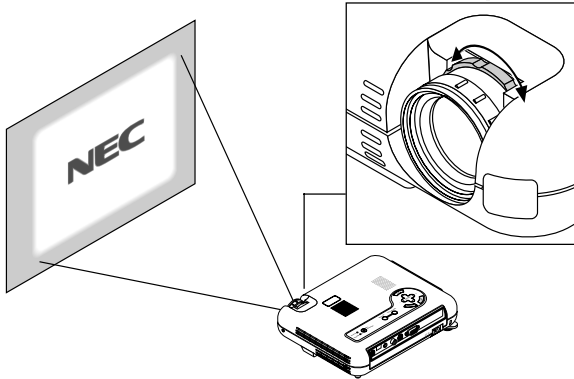

Use the Focus ring to obtain the best focus.

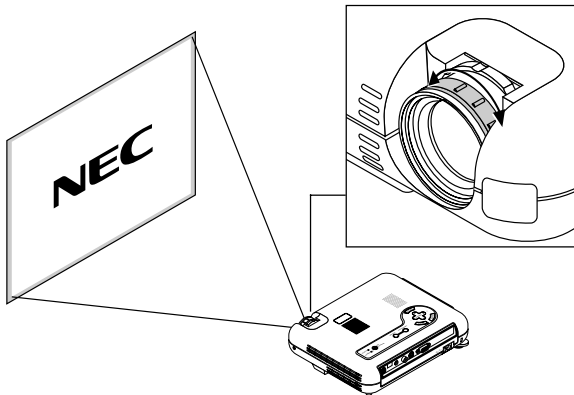

Place your projector on a flat level surface and Ensure that the projector is square to the screen.

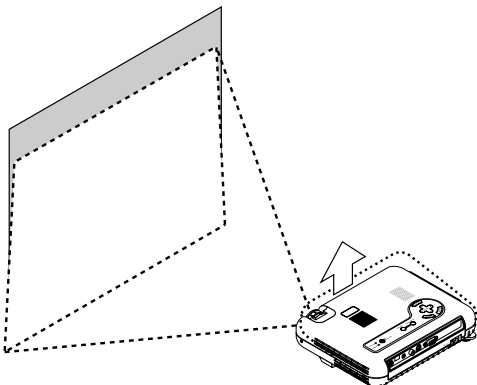

Lift the front edge of the projector to center the image vertically.

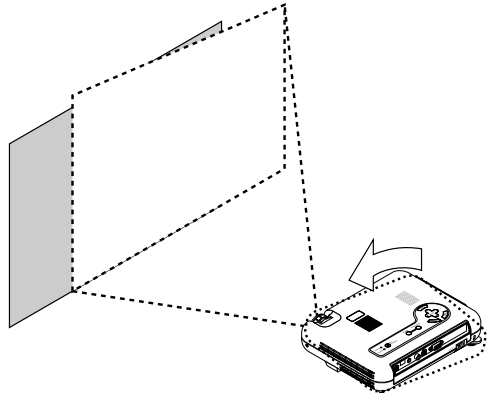

Move the projector left to center the image horizontally on the screen.

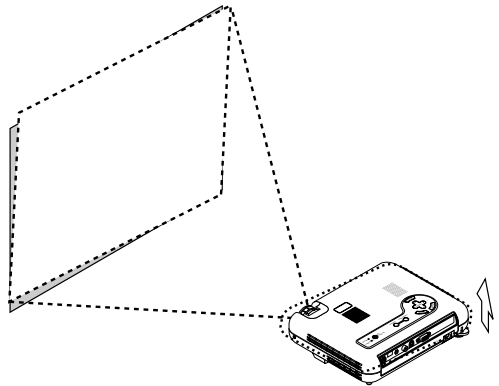

Rotate the rear foot to make the image square to the screen. Use keystone correction for proper adjustment.

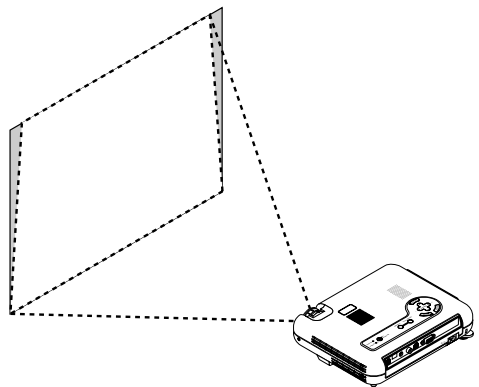

Adjusting the Tilt Foot

- 1) Lift the front edge of the projector.
- 2) Press the Tilt button on the top of the projector to extend the adjustable tilt foot (maximum height).

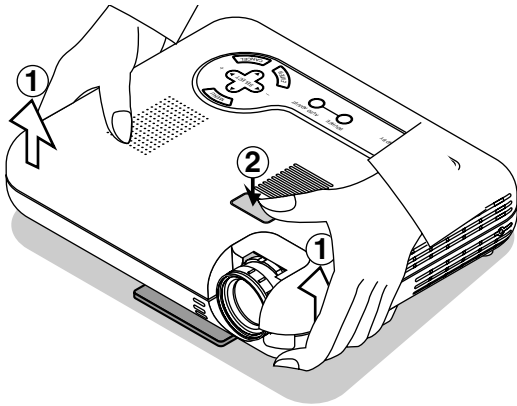

- 3) Press and hold the Tilt button.
 - 4) Lower the front of the projector to the desired height and release the button to lock the Adjustable tilt foot.
- There is approximately 5 degrees of up and down adjustment for the front of the projector. The rear foot height can be changed, but the vertical distance from the bottom to the desk or floor should be 0.14" (3.5mm) to make the projector horizontal on the flat surface. To fine-adjust the height of the rear foot, remove the spacer (black rubber) and rotate the rear foot to the desired height.

* If the projected image does not appear square to the screen then use keystone correction for proper adjustment.

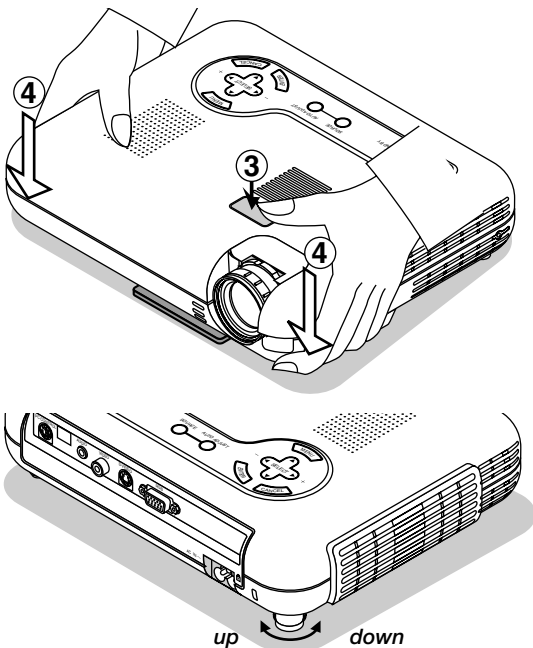

Do not use the tilt-foot for purposes other than originally intended. Misuses such as gripping the tilt-foot or hanging on the wall can cause damage to the projector.

Adjusting the Image Using Auto Adjust

The Auto Adjust function automatically optimizes the image in RGB mode.

[Poor picture]

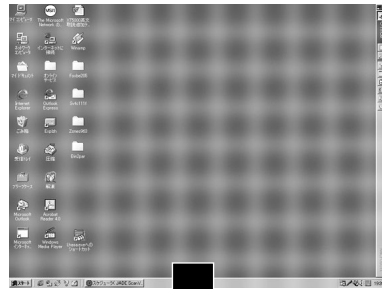

[Normal picture]

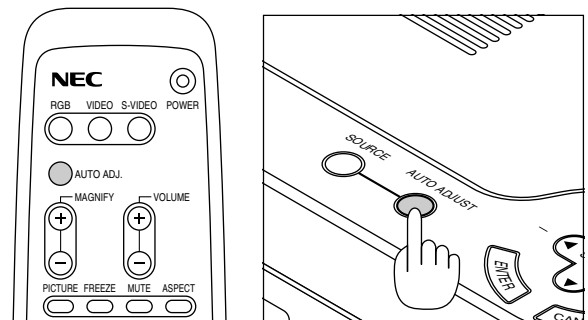
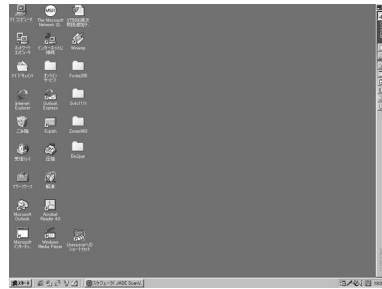

Press the Auto Adjust button to adjust Position-H/V and Pixel Clock/Phase for an optimal picture. Some signals may not be displayed correctly or take time to switch between sources.

NOTE: When using the Auto Adjust feature for the first time by pressing the "AUTO ADJUST" button or setting any adjustments to horizontal/vertical position, clock, or phase settings, the projector's micro-processor stores the adjusted data in memory.

The next time the source is selected, the projector will use this new data that is stored in memory.

Up to 10 presets can be stored in memory in a wraparound fashion. Once all 10 presets are used and new adjustments need to be stored, the oldest data will be deleted and the newest data will be stored.

Enlarging and Moving a Picture

You can enlarge the area you want up to 400 percent.

To do so:

Adjust the image size up to 400 percent.

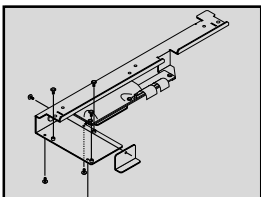
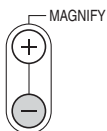
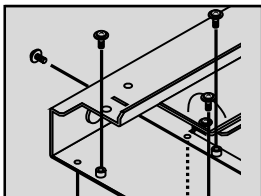
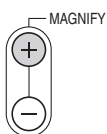

While the picture is enlarged, you can move it using the "Select" ◀, ▶, ▲, or ▼ button.

Using the Menu

1. Press the "Menu" button on the remote control or the projector cabinet to display the Menu.
2. Press the ▲▼ buttons on the remote control or the projector cabinet to highlight the menu for the item you want to adjust or set.
3. Press the ▶ button or the "Enter" button on the remote control or the projector cabinet to select a submenu or item.
4. Adjust the level or turn the selected item on or off by using "Select" ◀ or ▶ buttons on the remote control or the projector cabinet. The on-screen slide bar will show you the amount of increase or decrease.
5. The change is stored until you adjust it again.

CANCEL: Return to the previous screen.

6. Repeat steps 2-5 to adjust an additional item, or press "Cancel" on the remote control or the projector cabinet to quit the menu display.

MENU Tree

Basic/Advanced Menu

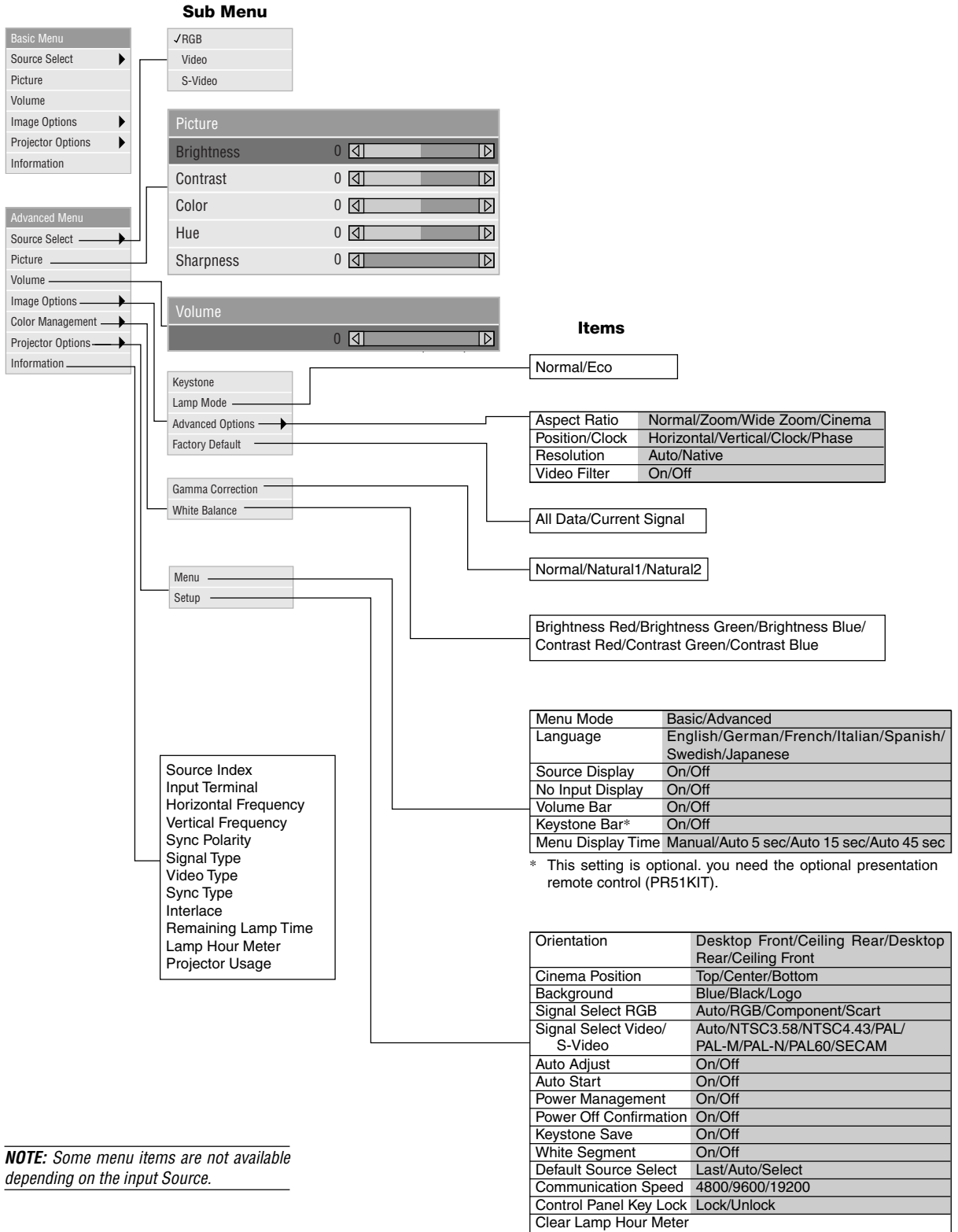

NOTE: Some menu items are not available depending on the input Source.

Menu Elements

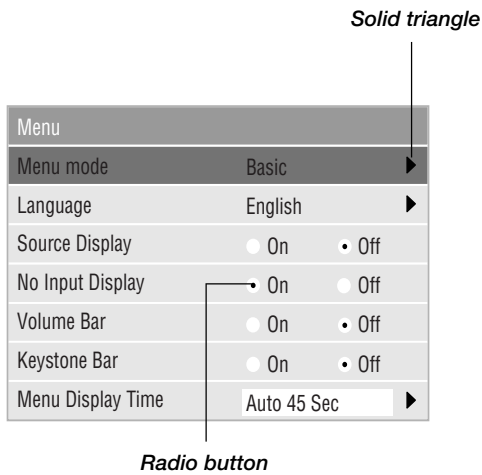
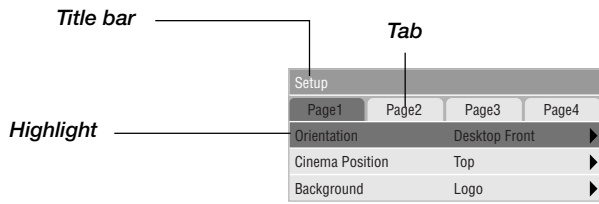

.....
 Menu windows or dialog boxes typically have the following elements:

- Title bar: Indicates the menu title.
- Highlight: Indicates the selected menu or item.
- Solid triangle: Indicates further choices are available. A highlighted triangle indicates the item is active.
- Tab: Indicates a group of features in a dialog box. Selecting on any tab brings its page to the front.
- Radio button: Use this round button to select an option in a dialog box.
- Slide bar: Indicates settings or the direction of adjustment.

Menu Descriptions & Functions

Source Select



Enables you to select a video source such as a VCR, DVD player, laser disc player, computer or document camera depending on what is connected to your inputs. Press the "Select" button on the projector cabinet or ▲▼ buttons on your remote control to highlight the menu for the item you want to adjust.

[RGB]

Selects the computer connected to your RGB or component signal.

NOTE: An optional component cable (Component V or ADP-CV1 cable) is needed for a component signal.

[Video]

Selects what is connected to your Video input-VCR, laser disc player, DVD player or document camera.

[S-Video]

Selects what is connected to your S-Video input-VCR, DVD player, or laser disc player.

NOTE: A frame may freeze for a brief period of time when a video is played back in fast-forward or fast-rewind with a Video or S-Video source.

Picture

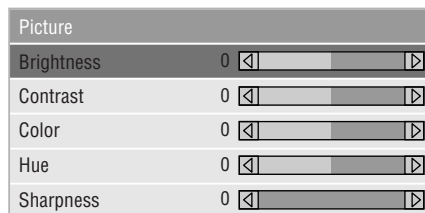

Provides access to controls for your image. Use the "Select" button on the projector cabinet or the remote control to highlight the menu for the item you want to adjust.

[Brightness]

Adjusts the brightness level or the back raster intensity.

[Contrast]

Adjusts the intensity of the image according to the incoming signal.

[Color]

Increases or decreases the color saturation level (not valid for RGB).

[Hue]

Varies the color level from +/- green to +/-blue. The red level is used as reference. This adjustment is only valid for Video and Component inputs (Not RGB).

[Sharpness]

Controls the detail of the image for Video (Not for RGB and Component).

Volume

Adjusts the sound level of the projector.



NOTE: You can display the volume bar without opening the menu. See "Volume Bar (Direct Button)" on page E-30 for more details.

Image Options

Basic Mode

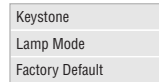

Advanced Mode



Provides optional controls such as Keystone Correction, Lamp Mode and Factory Default. When you select Advanced Mode, the following options are available: Aspect Ratio, Position/Clock, Resolution, and Video Filter.

Keystone



This feature corrects the keystone (trapezoidal) distortion to make the top of the screen longer or shorter to be the same as the bottom.

Use the ◀ or ▶ buttons on the slide bar to correct the keystone (trapezoidal) distortion.

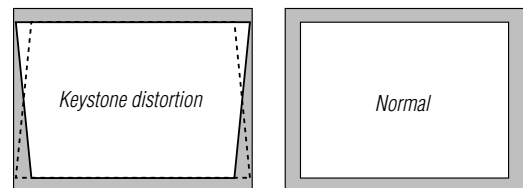

NOTE: The keystone angle can be corrected between 15 degrees upward and 15 degrees downward at a 0 degree-projection angle. Depending on the type of graphics being used, the picture may get blurred or keystone correction may not be possible when excessive keystone correction is used. The idea is, the closer you are to native resolution, the better image you will see.

Lamp Mode

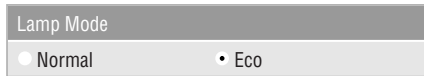

This feature enables you to select two brightness mode of the lamp:

Normal and Eco modes. The lamp life can be extended up to 1500 hours by using the Eco mode.

Normal Mode This is the default setting.

Eco Mode Select this mode to increase the lamp life.

NOTE: If you have selected the Eco mode, the lamp lights in Normal mode for one minute after the projector is turned on. After one minute the lamp will change to Eco mode.

Advanced Options (Advanced mode)

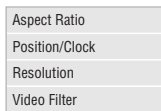

Allows for adjustments of image position and stability. When you select Advanced Options in Advanced mode, the following options are available: Aspect Ratio, Position/Clock, Resolution, and Video Filter.

Aspect Ratio:



Aspect Ratio allows you to select the best Aspect mode to display your source image. You can also display the Aspect Ratio window by pressing the "Aspect" button on the remote control. (See page E-12).

When 4:3 is selected from the source (i.e. DVD player), the following selections will display:

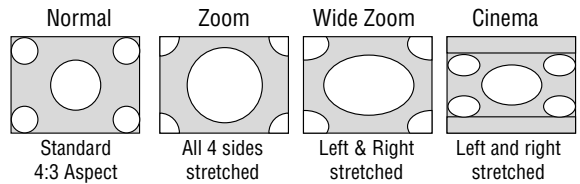

When 16:9 is selected from the source (i.e. DVD player), the following selections will display:

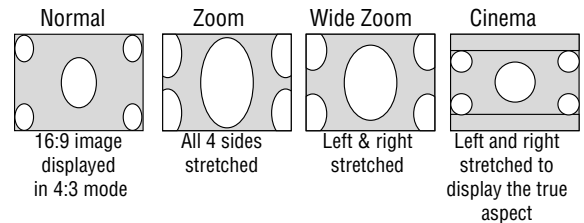

NOTE: You can select three image positions for Cinema: Top, center, and bottom. See page E-31 for setting Cinema position.

NOTE: Once the Aspect setting has been changed, the "Resolution" setting is automatically changed to "Auto".

Position/ Clock (when Auto Adjust is off):

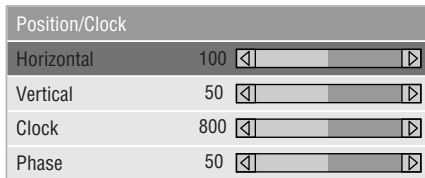

This allows you to manually adjust the image horizontally and vertically, and adjust Clock and Phase.

[Horizontal/Vertical Position]

Adjusts the image location horizontally and vertically using the ◀ and ▶ buttons.

This adjustment is made automatically when the Auto Adjust is turned on.

[Clock]

Use this item with the “Auto Adjust off” to fine tune the computer image or to remove any vertical banding that might appear. This function adjusts the clock frequencies that eliminate the horizontal banding in the image. Press the ◀ and ▶ buttons until the banding disappears. This adjustment may be necessary when you connect your computer for the first time. This adjustment is made automatically when the Auto Adjust is turned on.

[Phase]

Use this item to adjust the clock phase or to reduce video noise, dot interference or cross talk. (This is evident when part of your image appears to be shimmering.) Use the ◀ and ▶ buttons to adjust the image.

Use “Phase” only after the “Clock” is complete.

This adjustment is made automatically when the Auto Adjust is turned on.

See “Auto Adjust” on page E-32 for turning on or off the Auto Adjust feature.

Resolution (when Auto Adjust is off):

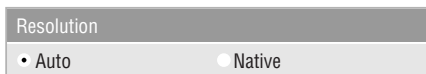

This allows you to activate or deactivate the Advanced AccuBlend feature.

Auto Turns on the Advanced AccuBlend feature. The projector automatically reduces or enlarges the current image to fit the full screen.

Native Turns off the Advanced AccuBlend feature. The projector displays the current image in its true resolution.

See “Auto Adjust” on page E-32 for turning on or off the Auto Adjust feature.

NOTE: When an image with a resolution of SVGA, XGA, SXGA or UXGA is displayed, the Resolution is not available.

NOTE: Once the Resolution setting has been changed, the “Aspect” setting is automatically changed to “Normal”.

Video Filter (when Auto Adjust is off):



This function reduces video noise.

On The low-pass filter is applied.

Off The low-pass filter is not applied.

Screen adjustments are possible even when the filter is on.

Factory Default



Changes all adjustments and settings to the factory preset.

[All Data]

Reset all the adjustments and settings for all the signals to the factory preset.

The items can be reset except Language, Communication Speed, Remaining Lamp Time, Lamp Hour Meter and Projector Usage. To reset the lamp usage time, see “Clear Lamp Hour Meter” page E-33.

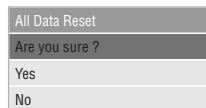

[Current Signal]

Resets the adjustments for the current signal to the factory preset levels.

The items that can be reset are: Brightness, Contrast, Color, Hue, Sharpness, Volume, Aspect, Horizontal Position, Vertical Position, Clock, Phase, Resolution, Video Filter, Gamma Correction, and White Balance.

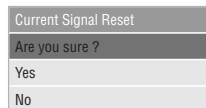

Color Management

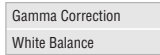

Gamma Correction (Advanced mode)



Use the ◀ or ▶ button to choose "Normal" when in a lighted room and "Natural 1&2" when in a darkened room. "Natural 1" for better flesh tone; "Natural 2" for true reproduction of middle tones.

Each mode is recommended for :

- Normal For the regular picture
- Natural 1 For true color reproduction of natural tones
- Natural 2 For dark portions of a picture

White Balance (Advanced mode)

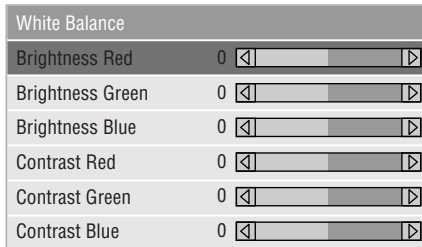

This allows you to adjust the white balance. Brightness for each color (RGB) is used to adjust the black level of the screen; Contrast for each color (RGB) to adjust the white level of the screen.

First use the ▲ or ▼ buttons to select R, G, or B for the brightness and the contrast. Next use the ◀ or ▶ buttons to adjust the level.

Projector Options



Menu

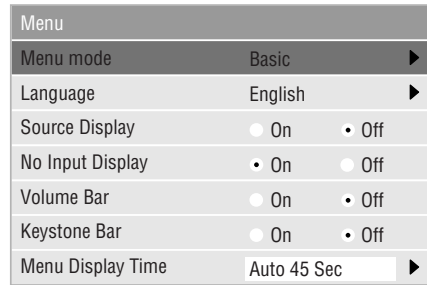

Allows you to set preferences for the on-screen menu.

[Menu Mode]

This feature allows you to select two menu modes: one has basic functionality and the other more advanced functionality.

Basic Mode This is the normal mode.

Advanced Mode This mode is used for advanced users.

[Language]

You can choose one of seven languages for on-screen instructions. The options are: English, German, French, Italian, Spanish, Swedish and Japanese.

NOTE: The "Language" setting cannot be reset back to "English" using the Factory Default function.

[Source Display]

You can turn on and off the information for input name such as VIDEO and RGB.

When this option is on, the current input will be displayed each time you switch sources or turn on the projector.

[No Input Display]

When this feature is turned on, the "No Input" message will appear if there is no signal present.

[Volume Bar]

This option turns on or off the volume bar when you adjust the sound volume using VOL+/- (up and down) button.

On You can increase or decrease the sound volume with the volume bar on screen.

NOTE: If no adjustments are performed within 3 seconds, the Volume bar will disappear.

Off You can increase or decrease the sound volume without having to use the volume bar.

[Keystone Bar]

This option is available on the optional presentation remote control (PR51KIT) only. This option turns on or off the keystone bar when you adjust the keystone using KEYSTONE +/- button on the optional presentation remote control.

- On You can increase or decrease the level with the keystone bar on screen.
- Off You can increase or decrease the level without having to use the keystone bar.

[Menu Display Time]

This option allows you to select how long the projector waits after the last touch of a button to turn off the menu.

The preset choices are "Manual", "Auto 5 sec", "Auto 15 sec", and "Auto 45 sec". The "Auto 45 sec" is the factory preset.

- Manual The menu can be turned off manually.
- Auto 5 sec The menu will automatically be turned off in 5 seconds if no buttons are pressed within 5 seconds.
- Auto 15 sec .. The menu will automatically be turned off in 15 seconds if no buttons are pressed within 15 seconds.
- Auto 45 sec .. The menu will automatically be turned off in 45 seconds if no buttons are pressed within 45 seconds.

Setup

Enables you to set operating options.

[Page1]

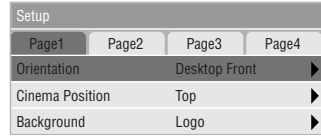

[Orientation]

This reorients your image for your type of projection. The options are: desktop front projection, ceiling rear projection, desktop rear projection, and ceiling front projection.

[Cinema Position]

This feature selects the vertical position of the image when viewing video with Cinema aspect ratio selected. When Cinema aspect ratio is selected on earlier models, the image is displayed with black borders on the top and bottom. You can select the vertical position among three options:

- Top Image position is at the top with a black border on bottom.
- Center Image position is at the center with black borders on top and bottom.
- Bottom Image position is at the bottom with a black border on top.

[Background]

Use this feature to display a black/ blue screen or logo when no signal is available.

[Page2] (Advanced mode)

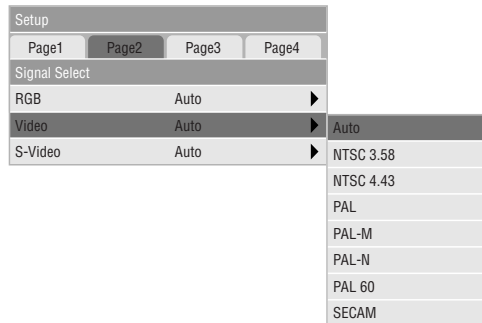

Signal Select:

[RGB]

Allows you to choose "RGB" for an RGB source such as a computer, or "Component" for a component video source such as a DVD player. Normally select "Auto" and the projector automatically detects a component signal. However there may be some component signals that the projector is unable to detect. If this is the case, select "Component". Select "Scart" for the European Scart.

[Video & S-Video System Select]

This feature enables you to select composite video standards manually. Normally select "Auto". When you select the video standard for Video and S-Video, select the video standard from the pull-down menu. This must be done for Video and S-Video respectively.

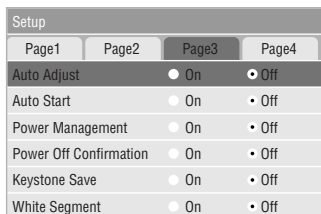

[Auto Adjust]

When “Auto Adjust” is set to “On”, the projector automatically determines the best resolution for the current RGB input signal to project an image using NEC’s Advanced AccuBlend Intelligent Pixel Blending Technology.

The image can be automatically adjusted for geometry and stability; “Horizontal Position”, “Vertical Position”, “Clock” and “Phase”.

On Automatically adjusts image “Horizontal Position”, “Vertical Position”, “Clock” and “Phase”.

Off User can adjust the image display functions (“Horizontal Position”, “Vertical Position”, “Clock” and “Phase”) manually.

[Auto Start]

Turns the projector on automatically when the power cable is inserted into an active power outlet and the main power switch is on. This eliminates the need to always use the “Power” button on the remote control or projector cabinet.

[Power Management]

When this option is on and there is no RGB input for five minutes or more, the projector will automatically turn itself off.

NOTE: *This feature does not work with Video or S-Video sources.*

[Power Off Confirmation]

This option determines whether a confirmation dialog for turning off the projector will appear or not.

[Keystone Save]

This option enables you to save your current keystone settings. Saving your change once affects all sources. The changes are saved when the projector is off.

[White Segment]

You can put emphasis on either brightness or color for a projected image.

If you prefer putting emphasis on brightness, place a checkmark in the box to turn the option on. If you prefer an image in truer color, turn off this option.

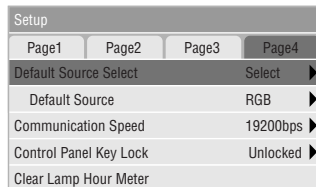

[Default Source Select]

You can set the projector to default to any one of its inputs each time the projector is turned on.

Last Sets the projector to default to the previous or last active input each time the projector is turned on.

Auto Searches for an active source in order of RGB → Video → S-Video and displays the first found source.

Select Displays the selected source input every time the projector is started up. Select an input from the pull-down menu.

[Communication Speed]

This feature sets the baud rate of the PC Control port (Mini DIN 8 Pin).

it supports data rates from 4800 to 19200 bps.

The default is 19200 bps. Select the appropriate baud rate for your equipment to be connected.

[Control Panel Key Lock]

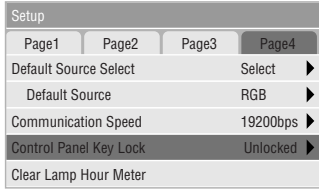

This option turns on or off the Control Panel Key Lock function.

NOTE:

- When the cabinet buttons are not locked, "Control Panel Key Lock - Unlock" will be displayed. When the cabinet buttons are locked, "Control Panel Key Lock - Locked" will be displayed.
- This Control Panel Key Lock does not affect the remote control and the PC Control functions.

To lock the cabinet buttons:

- 1) Use the Select ▲ or ▼ button to select "Control Panel Key Lock" and press the ENTER button. The submenu will be displayed.
- 2) Use the Select ▲ or ▼ button to select "Lock" and press the ENTER button. The following confirmation screen will be displayed.



- 3) Use the Select ▲ or ▼ button to select "Yes" and press the ENTER button.
The display will be changed to "Control Panel Key Lock - Lock" and be returned to the previous menu screen.

NOTE: When "No" is selected and the ENTER button is pressed, the display will not be changed and will be returned to the previous menu screen.

To unlock the cabinet buttons:

- 1) Use the Select ▲ or ▼ button on the remote control to select "Control Panel Key Lock" and press the ENTER button on the remote control. The submenu will be displayed.

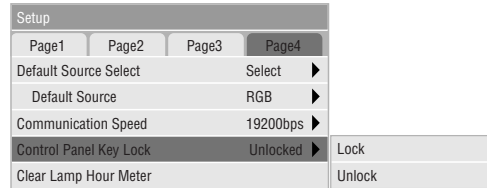

- 2) Use the Select ▲ or ▼ button on the remote control to select "Unlock" and press the ENTER button on the remote control. This change will take effect immediately.

NOTE:

- The confirmation screen will not be displayed.
- When the cabinet buttons are locked, pressing and holding the CANCEL button for about 10 seconds will change the setting from Locked to Unlocked.

[Clear Lamp Hour Meter]

Resets the lamp clock back to zero. Selecting this option displays submenu for a confirmation. To reset the lamp usage hour meter, use the ▲ or ▼ button to select "Yes".

NOTE: The projector will turn off and go into standby mode after 1100 hours (up to 1600 hours in Eco mode) of service. If this happens, press the "Help" button on the remote control for ten seconds to reset the lamp clock back to zero. Do this only after replacing the lamp.

Information

Displays the status of the current signal and lamp usage. This dialog box has three pages. The information included are as follows:

[Page 1]
Source Index
Input Terminal
Horizontal Frequency
Vertical Frequency
Sync Polarity

[Page 2]
Signal Type
Video Type
Sync Type
Interlace

[Page 3]
Remaining Lamp Time (%)*
Lamp Hour Meter (H)
Projector Usage (H)

- * When the remaining lamp time reaches 0, the Remaining Lamp Time bar indicator changes from 0% to 100 Hours and starts counting down.
If the remaining lamp time reaches 0 hours, the projector will not turn on regardless of whether the lamp mode is set to Normal or Eco.

NOTE: The progress indicator shows the percentage of remaining bulb life. The value informs you of the amount of lamp and projector usage respectively.

4. MAINTENANCE

This section describes the simple maintenance procedures you should follow to replace the lamp.

Replacing the Lamp

After your lamp has been operating for 1000 hours (1500 hours: Eco mode) or longer, the "Status" indicator in the cabinet will go on and the message will appear. Even though the lamp may still be working, replace it at 1000 hours (1500 hours: Eco mode) to maintain optimal projector performance.

CAUTION

- **DO NOT TOUCH THE LAMP** immediately after it has been used. It will be extremely hot. Turn the projector off, wait 90 seconds, and then disconnect the power cable. Allow at least one hour for the lamp to cool before handling.
- **DO NOT REMOVE ANY SCREWS** except the lamp cover screw and three lamp case screws. You could receive an electric shock.
- The projector will turn off and go into stand by mode after 1100 hours (1600 hours: Eco mode) of service. If this happens, be sure to replace the lamp. If you continue to use the lamp after 1000 hours (1500 hours: Eco mode) of use, the lamp bulb may shatter, and pieces of glass may be scattered in the lamp case. Do not touch them as the pieces of glass may cause injury. If this happens, contact your NEC dealer for lamp replacement.

To replace the lamp:

- 1 Loosen the lamp cover screw until the screwdriver goes into a freewheeling condition and remove the lamp cover. The lamp cover screw is not removable.

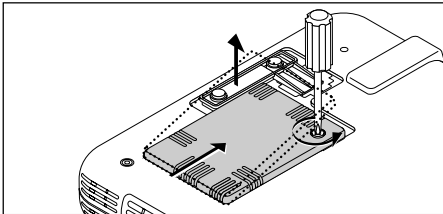

- 2 Loosen the three screws securing the lamp housing until the screwdriver goes into a freewheeling condition. The three screws are not removable.

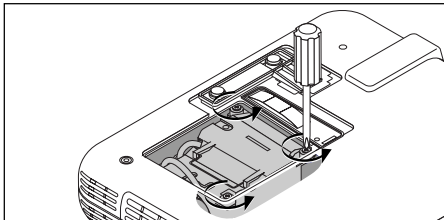

- 3 Remove the lamp housing by pulling out the handle.

NOTE: There is an interlock on this case to prevent the risk of electrical shock. Do not attempt to circumvent this interlock.

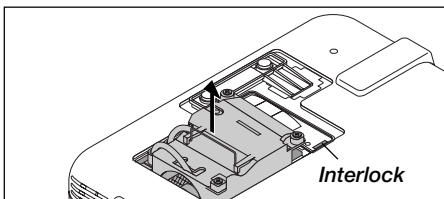

- 4 Insert a new lamp housing until the lamp housing is plugged into the socket.

CAUTION: Do not use a lamp other than the NEC replacement lamp (LT51LP). Order this from your NEC dealer.

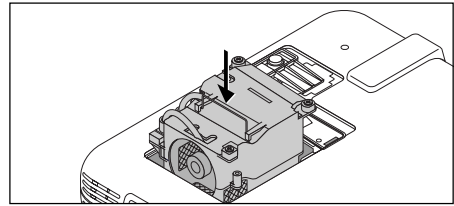

- 5 Secure it in place with the three screws. Be sure to tighten the screws.

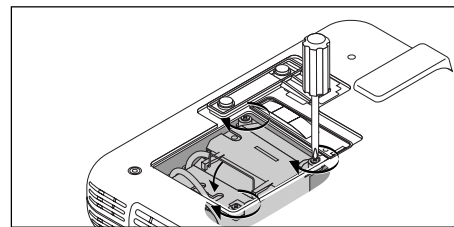

- 6 Reattach the lamp cover.

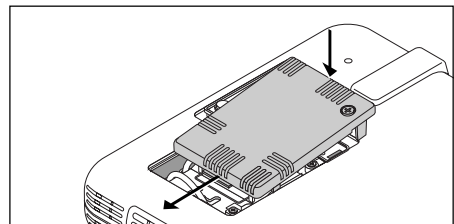

- 7 Tighten the lamp cover screw. Be sure to tighten the screw.

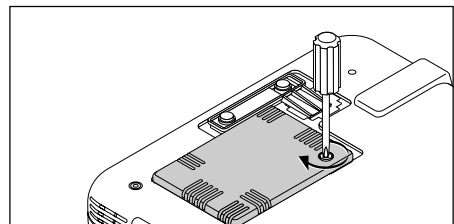

- 8 After you install a new lamp, select the [Advanced Menu] → [Projector Options] → [Setup] → [Page 4] → [Clear Lamp Hour Meter] to reset the lamp usage hours. If the projector will not be turned on after using 1100 hours (1600 hours: Eco mode) of service, press and hold the [Help] button on the remote control for ten seconds or longer to reset the lamp time clock to zero.

5. TROUBLESHOOTING

This section helps you resolve problems you may encounter while setting up or using the projector.

Power/Status Light Messages

Condition	Power Indicator	Status Indicator	Note
Standby	Steady orange	–	–
Cooling down	Blinking green	–	Blinks green for 90 seconds
Lamp in Normal mode	Steady green	–	–
Lamp in Eco mode	Steady green	Steady green	–
Retrying to turn on lamp	Steady green	Blinking orange	The projector retries 3 times at an interval of 15 sec for max. 45 sec)
One minute after lamp is turned on	Blinking green	No light in Normal mode / Steady green in Eco mode	–
Lamp has reached its end of life (Normal: 1000 hours or over) (Eco: 1500 hours or over)	Steady green	Steady red	Message appears on screen during 1000-1100 hours (1500-1600 hours: Eco mode) of lamp usage. The projector reaches its end of life. Please replace the lamp as soon as possible
Lamp life has reached its end of life (Normal: 1100 hours or over) (Eco: 1600 hours or over)	Steady orange	Steady red	The projector is in standby mode and cannot be turned on.
Lamp cover error	Steady orange	Blinking red (1 sec interval)	The projector is in standby mode and cannot be turned on.
Temperature error	Steady orange	Blinking red (4 sec interval)	The projector is in standby mode and cannot be turned on.
Fan error	Steady orange	Blinking red (8 sec interval)	The projector is in standby mode and cannot be turned on.
Lamp error	Steady orange	Blinking red (12 sec interval)	The projector is in standby mode and cannot be turned on.

Common Problems & Solutions

Problem	Check These Items
Does not turn on	<ul style="list-style-type: none"> • Check that the power cable is plugged in and that the power button on the projector cabinet or the remote control is on. • Ensure that the lamp cover is installed correctly. See page E-34. • Check to see if the projector has overheated or the lamp usage exceeds 1100 hours. If there is insufficient ventilation around the projector or if the room where you're presenting is particularly warm, move the projector to a cooler location.
No picture	<ul style="list-style-type: none"> • Use the menu to select your source (Video, S-Video or RGB). See page E-27. • Ensure your cables are connected properly. • Use menus to adjust the brightness and contrast. See page E-27. • Remove the lens cap. • Reset the settings or adjustments to factory preset levels using the Factory Default in the Adjustment Menu. See page E-29.
Image isn't square to the screen	<ul style="list-style-type: none"> • Reposition the projector to improve its angle to the screen. See page E-22. • Use the Keystone in the Adjustment Menu to correct the trapezoid distortion. See page E-27.
Picture is blurred	<ul style="list-style-type: none"> • Adjust the focus. See page E-22. • Reposition the projector to improve its angle to the screen. See page E-22. • Ensure that the distance between the projector and screen is within the adjustment range of the lens. See page E-14.
Image is scrolling vertically, horizontally or both	<ul style="list-style-type: none"> • Use menus or Source button on the remote control or the cabinet to select the source you want to input.
Remote control does not work	<ul style="list-style-type: none"> • Install new batteries. See page E-13. • Make sure there are no obstacles between you and the projector. • Stand within 22 feet (7 m) of the projector. See page E-13.
Status indicator is lit or blinking	<ul style="list-style-type: none"> • See the Status Light messages above.
Cross color in RGB mode	<ul style="list-style-type: none"> • If Auto Adjust is off, turn it on. If Auto Adjust is on, turn it off and balance the image with the Position/Clock in the Image Options. See page E-29 or E-32.

6. SPECIFICATIONS

This section provides technical information about the LT75Z Projector's performance

Model Number **LT75Z**

Optical

DMD™	Single Chip Digital Micromirror Device(DMD™), 800×600 dots
Lens	Manual Zoom, Manual focus: F2.6 – 2.8 f = 28.3 – 34.0 mm
Lamp	135W NSH lamp (The lamp is warranted for 1000 hours of operation time within 6 months.)
Image Size	30 - 200 inches (0.8 - 5.1 m) diagonal
Projection Distance	4.13 - 32.97ft (1.26 - 10.05m)

Electrical

Inputs	Video (NTSC/PAL/PAL-N/PAL-M/PAL60/SECAM/NTSC4.43) Horizontal Frequency : 15 -100 kHz (RGB : 24 kHz or over) Vertical Frequency : 50 -120Hz
Video Bandwidth	RGB: 80 MHz (-3dB)
Color Reproduction	Full color, 16.7 million colors simultaneously.
Horizontal Resolution	550 TV lines: NTSC/PAL/YCbCr 300 TV lines: SECAM RGB: 800 dots horizontal, 600 dots vertical
Power Requirement	100 - 120/200 - 240V AC, 50 / 60 Hz
Input Current	2.1A (100 - 120V AC) / 1.0A (200 - 240V AC)

Mechanical

Dimensions	9.6" (W) x 2.1" (H) x 7.7" (D) / 243mm (W) x 53mm (H) x 196mm (D) (not including protrusions)
Net Weight	3.3 lbs / 1.5 kg
Environmental	
Considerations	Operational Temperatures: 41° to 95°F (5° to 35°C), 20 to 80% humidity (non-condensing) Storage Temperatures: 14° to 122°F (-10° to 50°C), 20 to 80% humidity (non-condensing)
Regulations	UL Approved (UL 1950, CSA 950) Meets DOC Canada Class B requirements Meets FCC Class B requirements Meets AS/NZS3548 Class B Meets EMC Directive (EN55022, EN55024, EN61000-3-2, EN61000-3-3) Meets Low Voltage Directive (EN60950, TUV GS Approved)



We provide information about our projectors through the World Wide Web at <http://www.nec-pj.com/>

Digital Light Processing, DLP, Digital Micromirror Device and DMD are trademarks of Texas Instruments. The specifications are subject to change without notice.

Cabinet Dimensions

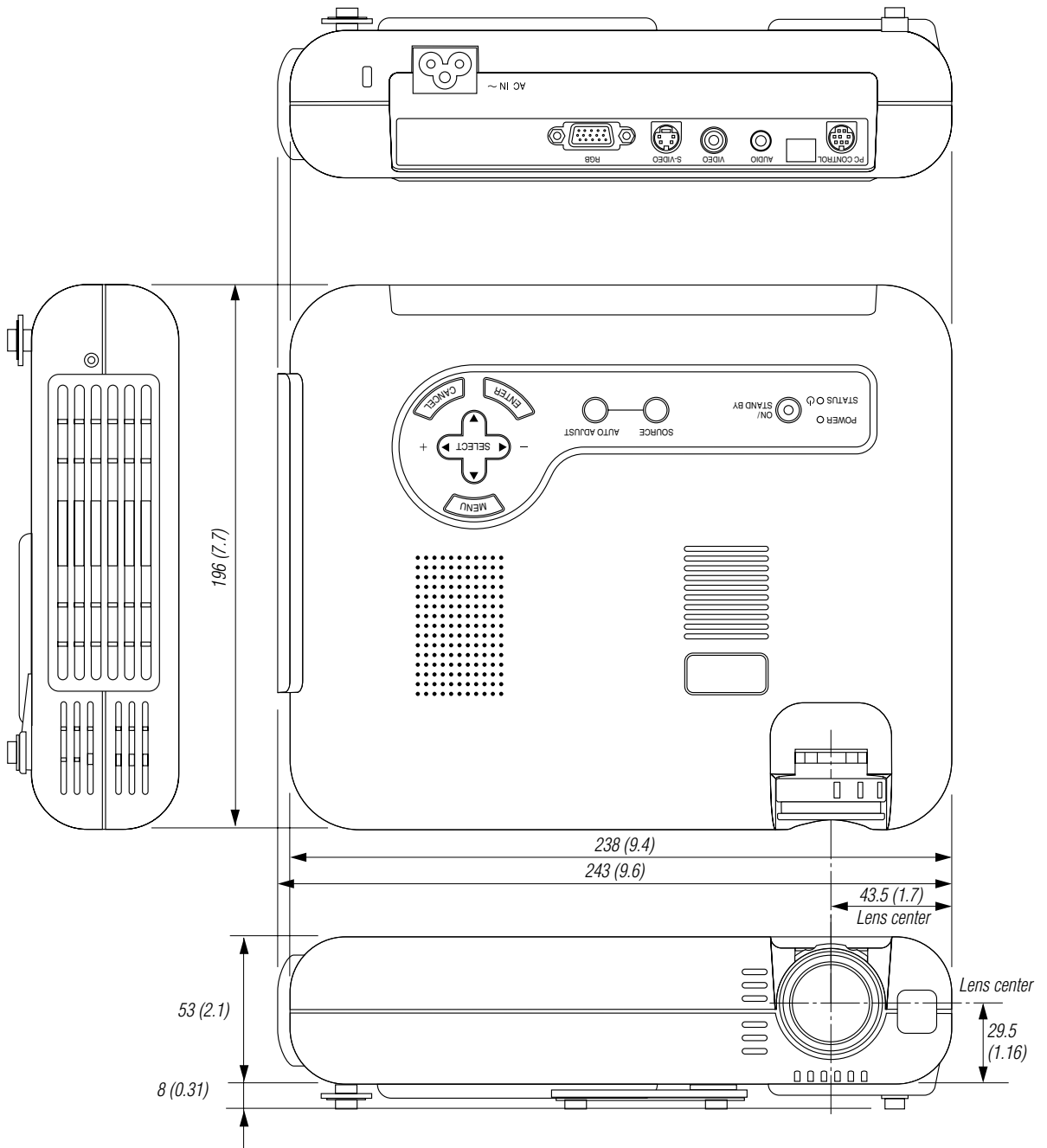

Unit = mm (inch)

D-Sub Pin Assignments

Mini D-Sub 15 Pin Connector

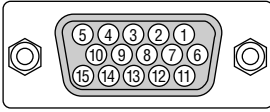

Signal Level
Video signal : 0.7Vp-p (Analog)
Sync signal : TTL level

Pin No.	RGB Signal (Analog)	YCbCr Signal
1	Red	Cr
2	Green or Sync on Green	Y
3	Blue	Cb
4	Ground	
5	Ground	
6	Red Ground	Cr Ground
7	Green Ground	Y Ground
8	Blue Ground	Cb Ground
9	No Connection	
10	Sync Signal Ground	
11		
12	Bi-directional DATA (SDA)	
13	Horizontal Sync or Composite Sync	
14	Vertical Sync	
15	Data Clock	

Compatible Input Signal List

Signal	Resolution (Dots)	Frequency H. (kHz)	Refresh Rate (Hz)	Dot Clock (MHz)
NTSC	–	15.734	60	-
PAL	–	15.625	50	-
SECAM	–	15.625	50	-
VESA	640 × 480	31.47	59.94	25.175
IBM	640 × 480	31.47	60	25.175
MAC	640 × 480	31.47	60	25.175
MAC	640 × 480	34.97	66.67	31.334
MAC	640 × 480	35	66.67	30.24
VESA	640 × 480	37.86	72.81	31.5
VESA	640 × 480	37.5	75	31.5
IBM	640 × 480	39.375	75	31.49
VESA	640 × 480	43.269	85.01	36
IBM	720 × 350	31.469	70.09	28.322
VESA	720 × 400	37.927	85.04	40
IBM	720 × 350	39.44	87.85	35.5
IBM	720 × 400	39.44	87.85	35.5
VESA	800 × 600	35.16	56.25	36
VESA	800 × 600	37.879	60.32	40
VESA	800 × 600	48.077	72.19	50
VESA	800 × 600	46.88	75	49.5
VESA	800 × 600	53.674	85.06	56.25
# MAC	832 × 624	49.725	74.55	57.283
# VESA	1024 × 768	35.5	43 Interlaced	44.9
# VESA	1024 × 768	48.363	60	65
# VESA	1024 × 768	57.476	70.07	75
# MAC	1024 × 768	60.241	74.93	80
# VESA	1024 × 768	60.023	75.03	78.75
# VESA	1024 × 768	68.677	85	94.5
# VESA	1152 × 864	67.5	75	108
# MAC	1152 × 870	68.681	75.6	100
# SUN	1152 × 900	61.796	65.95	92.94
# SGI	1152 × 900	71.736	76.05	105.6
# VESA	1280 × 960	60	60	108
# VESA	1280 × 1024	64.286	60.02	108
# MAC	1280 × 1024	65.2	69.89	118.5
# HP	1280 × 1024	78.125	72.01	135
# SUN	1280 × 1024	81.13	76.11	135
# VESA	1280 × 1024	79.976	75.03	135
# VESA	1280 × 1024	91.146	85.02	157.5
# HDTV (1080i)(1125i)	1920 × 1080	33.75	60 Interlace	74.25
# HDTV (1080i)(1125i)	1920 × 1080	28.13	50 Interlace	74.25
# HDTV (720p)(750p)	1280 × 720	45	60 Progressive	74.25
# SDTV (480p)(525p)	–	31.47	59.94 Progressive	27
# SDTV (480i)(525i)	–	15.73	59.9 Interlace	–
# VESA	1600 × 1200	75.0	60	162
# VESA	1600 × 1200	81.3	65	175.5
# VESA	1600 × 1200	87.5	70	189
# VESA	1600 × 1200	93.75	75	202.5

#: Images in above flagged with # are compressed with Advanced AccuBlend.

NOTE1: Some composite sync signals may not be displayed correctly.

NOTE2: Signals other than those specified in the table above may not be displayed correctly. If this should happen, change the refresh rate or resolution on your PC. Refer to Display Properties help section of your PC for procedures.

NOTE3: UXGA (1600×1200) is supported for separate sync signal only.

PC Control Codes

Function	Code Data
POWER ON	02H 00H 00H 00H 00H 02H
POWER OFF	02H 01H 00H 00H 00H 03H
INPUT SELECT RGB	02H 03H 00H 00H 02H 01H 01H 09H
INPUT SELECT VIDEO	02H 03H 00H 00H 02H 01H 06H 0EH
INPUT SELECT S-VIDEO	02H 03H 00H 00H 02H 01H 0BH 13H
PICTURE MUTE ON	02H 10H 00H 00H 00H 12H
PICTURE MUTE OFF	02H 11H 00H 00H 00H 13H
SOUND MUTE ON	02H 12H 00H 00H 00H 14H
SOUND MUTE OFF	02H 13H 00H 00H 00H 15H

NOTE: Contact your local dealer for a full list of PC Control Codes if needed.

Cable Connection

Communication Protocol

Baud rate: 19200 bps
 Data length: 8 bits
 Parity: No parity
 Stop bit: One bit
 X on/off: None
 Communications procedure: Full duplex

PC Control Connector (DIN-8P)

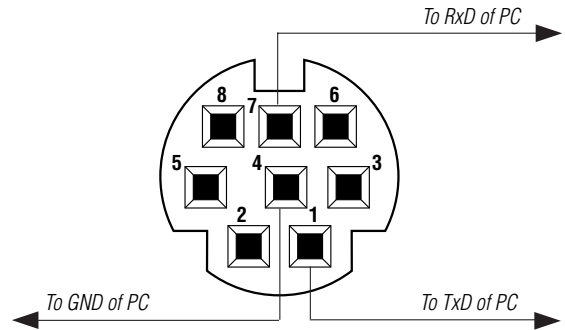

NOTE: Pins 2, 3, 5, 6 and 8 are used inside the projector.